

UL Certified Relays Catalog



ABOUT ELKO EP NORTH AMERICA

ELKO EP North America is a fast-growing US-based company representing a globally renowned brand with a 30-year history on the NA market under private labels, exporting to 80 countries with 15 branches worldwide. We are embarking on a new venture, proudly bringing the globally recognized ELKO brand directly to businesses and customers all across North America. With our headquarters nestled in the vibrant city of Miami and a strategically located warehouse in Louisville, KY, we can ensure a prompt service and product availability.

While our North American operations continue to thrive, our global reach is expansive. Under private labels, we collaborate with renowned entities worldwide, underscoring our global expertise and commitment to excellence. Our products are recognized for their high quality, holding UL, CE and EAC certifications.

Internationally, ELKO EP stands out as the largest DIN Rail Relay Manufacturer in the European Union. Our European headquarters consists of 400 dedicated employees, with 45 specialists engaged in Research & Development, pushing the boundaries of innovation. With a revenue of 40 million USD, our commitment to quality, innovation, and customer satisfaction remains paramount.



Jan Pacovsky
Managing Member, CEO

Cell: +1 (608)746-1332

Email: pacovsky@elkoepna.com

www.elkoepna.com

5 Reasons to Become a Partner

- **Work Directly with the Manufacturer**

Forge a direct connection with the visionaries behind the products. Our EU-based R&d and manufacturing are enhanced by US-based warehouse, customer care and tech support.

- **US-Stocked Products**

Our commitment to local stock ensures zero drop-shipping and guarantees a swift delivery window of just 1-10 days.

- **Quality Endorsed by the North American Market**

Manufacturing for industry giants under private labels, ELKO EP products have been tested by the NA market and stood up to the highest standards.

- **US-Based Technical Support and Customer Care**

Our US-based team is ready to support you on all technical inquiries, with regular workshops being held for distributors. Customer care is available through phone and email, with average reply times of under 24h

- **An Unbeatable Price Advantage**

Savor the competitive edge with our direct-to-customer model, presenting partners with a lucrative margin.

Attained awards & Memberships



Electronic Components
Industry Association member



Vodafone
Company of the
Year 2012



Electronics
Representatives
Association member



Technology Fast 50



Global exporter
in 2016

...and many others.



ABOUT ELKO EP HOLDING

ELKO EP has been your partner in the field for 30 years, developing and manufacturing the highest quality electronic devices for electroinstallation and smart systems for residential and building automation.

ELKO EP employs more than 400 people across 15 foreign branches and exports its products to more than seventy countries. Company of the Year, Visionary of the Year, Superbrands and Global Exporter of the Year are just some of the awards we have received throughout the years as we consistently strive to move forward in the field of innovation and development.

Millions of relays, thousands of smart homes, hundreds of buildings and many satisfied customers - This is ELKO EP; a traditional company based in the center of Europe, where own development, production, logistics, and service are at the forefront of our focus.

Facts and stats



30 %

Czech

40 %

Export

30 %

Branches



WORLDWIDE

11 Branches
3 Franchises
80 Export Countries

400

Employees
in Holding

30 000 +

iNELS
Installations

30 000 000 +

Manufactured
Products

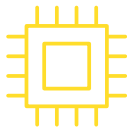

R&D

Continuously
Innovative

MANUFACTURER

Fully Automated
Complete Process

SUPPORT

24 / 7 / 365

World leader
In DIN Rail Relays Production

Product lines ELKO EP



Timers/Relays

Time relays, auxiliary relays, installation contactors, memory and bistable relays, staircase switches, time switches, twilight and light switches, dimmers and light intensity controllers, power supplies and bell transformers, controlling and signalling devices.

www.elkoep.com/relays



Monitoring Relays

Voltage relays 1-phase and 3-phase (undervoltage, overvoltage, phase failure, phase asymmetry and phase sequence), current relays, liquid level relays, thermostats, voltage indicator, power factor and frequency monitoring relays.

www.elkoep.com/monitoring

Multifunction current monitoring relay in 1P - PRI-34

It is a new line of PRI-34 current monitoring relays in a **multifunction** design. All types now measure **TRUE RMS** values (thus with minimal fault regardless of the shape of measured current). Of course, it is possible to **connect external current transformers** (possible extension of the measured range up to 1600A). There is a choice of eight functions incl. the memory ones.

Individual types are divided according to the nominal monitored current:

- PRI-34/1 A – monitored range AC 0.05 - 1 A
- PRI-34/2 A – monitored range AC 0.1 - 2 A
- PRI-34/5 A – monitored range AC 0.25 - 5 A
- PRI-34/8 A – monitored range AC 0.4 - 8 A
- PRI-34/16 A – monitored range AC 0.8 - 16 A



Multifunction voltage monitoring relay in 1P - HRN-3x, PMR1

The original HRN-3x types on a DIN rail will be replaced by new ones that are **multifunction** and bring several improvements. Now you have options with **one or two** output contacts. The **design into a socket** is the PMR1 model. As well as the previous novelty, also this one measures **TRUE RMS** values. This is related with monitoring of **DC voltage in higher ranges**. The original DC range was slightly modified for optional monitoring of 24V batteries. Multifunctionality enables the selection of up to nine functions incl. memory ones. Also an **external input** for memory reset was added.

Individual types are divided according to the monitored range:

On DIN rail:

- HRN-31, HRN-31/2, HRN-32/2 – monitored range AC/DC 48 to 276V
- HRN-36, HRN 36/2 – monitored range DC 6 to 30V
- HRN-39, HRN 39/2 – monitored range AC/DC 24 to 150V

Into a socket:

- PMR1-31, PMR1-31/2 – monitored range AC/DC 48 to 276V
- PMR1-36, PMR1-36/2 – monitored range DC 6 to 30V
- PMR1-39, PMR1-39/2 – monitored range AC/DC 24 to 150V



| | DESIGN | |
|--|------------------|----|
| TIME RELAYS - MULTIFUNCTION | | |
| CRM-161 Multifunction time relay - economy version | (1-MODULE) | 11 |
| CRM-91H, CRM-92H, CRM-93H Multifunction time relays - BESTSELLER | (1-MODULE) | 12 |
| CRM-111H, CRM-112H, CRM-113H Multifunction time relays with inhibit delay | (1-MODULE) | 14 |
| CRM-121H Multifunction time relay with galvanically separated control input | (1-MODULE) | 16 |
| CRM-131H Multifunction time relay with three control inputs | (1-MODULE) | 18 |
| CRM-82TO True off delay time relay | (1-MODULE) | 20 |
| TIME RELAYS - SINGLEFUNCTION, SPECIAL | | |
| CRM-2T STAR (Λ)/ DELTA (Δ) time relay | (1-MODULE) | 21 |
| CRM-181J, CRM-182J, CRM-183J Singlefunction time relays | (1-MODULE) | 22 |
| CRM-2H Asymmetric flasher | (1-MODULE) | 24 |
| TIME RELAYS - PLUG-IN | | |
| PTRM-216TP, PTRM-216KP Multifunction time relays with inhibit delay | (11-PIN) | 25 |
| PTRM-216T, PTRM-216K Multifunction time relays with potential-free control input | (11-PIN) | 27 |
| PTRA-216T, PTRA-216K Multifunction time relays with three control inputs | (11-PIN) | 29 |
| VOLTAGE 1-PHASE | | |
| HRN-31, HRN-32/2, HRN-39 Multifunction voltage monitoring relays in 1P - AC/DC | (2-MODULE) | 33 |
| HRN-36 Multifunction voltage monitoring relay in 1P - DC | (2-MODULE) | 33 |
| PMR1-31, PMR1-39 Multifunction voltage monitoring relays in 1P - AC/DC | (8-PIN) | 35 |
| PMR1-36 Multifunction voltage monitoring relay in 1P - DC | (8-PIN) | 35 |
| VOLTAGE 3-PHASES | | |
| HRN-56 Voltage monitoring relays in 3P with adjustable level Umin | (1/3-MODULE) | 37 |
| HRN3-70, PMR3-70 Voltage monitoring relays in 3P with selectable range | (3-MODULE/8-PIN) | 38 |
| HRN3-80, HRN3-81 Voltage monitoring relays in 3P - selectable range (HRN3-80), fixed range (HRN3-81) | (1-MODULE) | 40 |
| CURRENT | | |
| PRI-32 Current monitoring relay of I_{max} level passing through a hole in 1P - AC | (1-MODULE) | 43 |
| PRI-34 Multifunction current monitoring relays in 1P - AC | (1-MODULE) | 44 |
| PRI-51 Current monitoring relays of I_{max} level in 1P - AC | (1-MODULE) | 46 |
| AUXILIARY RELAYS | | |
| VS116U, VS308U, Auxiliary relays | (BOX/1-MODULE) | 48 |
| DIGITAL TIME SWITCHES | | |
| SHT-13, SHT-13/2 Multifunction digital time switch with Wi-Fi connection | (2-MODULE) | 51 |
| POWER SUPPLIES AND BELL TRANSFORMERS | | |
| PS1M, PS2M, PS3M, PS4M, PS6M Switching power supplies DC - unregulated | (1/2/3/4-MODULE) | 53 |
| INSTALLATION CONTACTORS | | |
| VS120, VS220, VS325, VS340, VS363, VS425, VS440, VS463 Installation contactors | (1/2/3-MODULE) | 56 |
| NON-UL PRODUCTS | | |
| CRM-91HE, CRM-2HE, CRM-9S, HRN-100, HRH-5, MR-41, MR-42, TER-7, TER-9, SJR-2 | (1/2-MODULE) | 60 |
| USE CASES - TOP 10 NEW RELAYS | | |
| HRN-31, HRN-32/2, HRN-36, HRN-39, HRN3-81, SHT-13 / SHT-13/2, PRI-34, HRN3-70, PMR1-31, PMR1-36/2 | (1/2-MODULE) | 62 |
| USE CASES - TOP 10 NEW RELAYS BY US SALES | | |
| CRM-161, CRM-183J ZR, CRM-2H, CRM-82TO, CRM-91H, CRM-93H, HRN-56, PRI-51, VS116U, VS308U | (1-MODULE) | 64 |
| TECHNICAL DETAILS | | |
| Loadability of products | | 69 |
| Product packaging | | 71 |
| Dimensions | | 72 |
| Examples of use | | 75 |

Multifunction



CRM-161

6 functions, 6 time ranges, output contact 1x 8 A changeover, power supply AC 24-240 V, DC 24 V, economy version of CRM-91H. page 11



CRM-91H

10 functions, 10 time ranges, 1x output 16 A changeover/SPDT, multivoltage or 230 V supply. page 12



CRM-92H

10 functions, 10 time ranges, 2x output 16 A changeover/SPDT, multivoltage or 230V supply. page 12



CRM-93H

As CRM-91H, but output 1x 16 A + 2x 8 A changeover/SPDT. page 12



CRM-111H

11 functions 10 time ranges, output contact: 1x 16 A changeover. page 16



CRM-112H

10 functions, 10 time ranges, output contact: 2x 16 A changeover, mode selection of output contact. page 16



CRM-113H

10 functions, 10 time ranges, output contact: 1x 16 A + 2x 8 A changeover, mode selection of output contacts. page 16



CRM-121H

As CRM-111H, but with galvanically separated input. page 18



CRM-131H

11 functions, 10 time ranges, output contact: 1x 16 A changeover, three control inputs. page 18



CRM-82TO

"TRUE OFF DELAY relay - switch off after power supply failure for backup circuits. page 20

Singlefunction, special



CRM-2T

Star/delta timer relay page 21



CRM-181J

Variants of 4 functions with time range 0.1s - 100 h, output 1x 16 A changeover, UNI power supply. page 22



CRM-182J

Variants of 4 functions with time range 0.1s - 100 h, output 2x 16A changeover, UNI power supply. page 22



CRM-183J

As CRM-181J, but output 1x16A + 2x 8 A changeover. page 22



CRM-2H

Asymmetric flasher, independent time setting ON/OFF. page 24

PLUG-IN



PTRM-216TP

10 functions, 10 time ranges, output contact: 2x 16 A changeover, voltage dependent input, mode selection of output contact, tuning with dials. page 25



PTRM-216KP

As PTRM-216TP, but fine tuning using a knob. page 25



PTRM-216T

10 functions, 10 time ranges, output contact: 2x 16 A changeover, potential-free input, mode selection of output contact, dial tuning. page 27



PTRM-216K

As PTRM-216T, but fine tuning using a knob. page 27



PTRA-216T

10 function, 10 time ranges, output contact 2x 16 A changeover, three control inputs and mode selection of output contact, tuning with dials. page 29



PTRA-216K

As PTRA-216T, but fine tuning help with a knob. page 29

| | CRM-161 | CRM-91H | CRM-92H | CRM-93H | CRM-111H | CRM-112H | CRM-113H | CRM-121H | CRM-131H | CRM-82TO | CRM-2T | CRM-181JZR | CRM-181JZN | CRM-181JBL | CRM-181JOD | CRM-182JZR | CRM-182JZN | CRM-182JBL | CRM-182JOD | CRM-183JZR | CRM-183JZN | CRM-183JBL | CRM-183JOD | CRM-2H | PTRM-216TP | PTRM-216KP | PTRM-216T | PTRM-216K | PTRA-216T | PTRA-216K | |
|---------------------------------------|---------|---------|---------|---------|----------|----------|----------|----------|----------|----------|--------|------------|------------|------------|------------|------------|------------|------------|------------|------------|------------|------------|------------|--------|------------|------------|-----------|-----------|-----------|-----------|---|
| Design | | | | | | | | | | | | | | | | | | | | | | | | | | | | | | | |
| 1-MODULE | ● | ● | ● | ● | ● | ● | ● | ● | ● | ● | ● | ● | ● | ● | ● | ● | ● | ● | ● | ● | ● | ● | ● | ● | ● | | | | | | |
| 3-MODULE | | | | | | | | | | | | | | | | | | | | | | | | | | | | | | | |
| PLUG-IN | | | | | | | | | | | | | | | | | | | | | | | | | | ● | ● | ● | ● | ● | ● |
| Under the switch | | | | | | | | | | | | | | | | | | | | | | | | | | | | | | | |
| Control elements | | | | | | | | | | | | | | | | | | | | | | | | | | | | | | | |
| Rotary switches/potentiometers | ● | ● | ● | ● | ● | ● | ● | ● | ● | ● | ● | ● | ● | ● | ● | ● | ● | ● | ● | ● | ● | ● | ● | ● | ● | ● | ● | ● | ● | ● | ● |
| Large rotary knob | | | | | | | | | | | | | | | | | | | | | | | | | | | ● | | ● | | ● |
| Buttons | | | | | | | | | | | | | | | | | | | | | | | | | | | | | | | |
| External potentiometer | | | | | | | | | | | | | | | | | | | | | | | | ● | | | | | | | |
| Time range | | | | | | | | | | | | | | | | | | | | | | | | | | | | | | | |
| 50 ms – 0.5 s | | | | | ● | ● | ● | ● | ● | | | | | | | | | | | | | | | | | | ● | ● | ● | ● | ● |
| 0.1 – 1 s | ● | ● | ● | ● | ● | ● | ● | ● | ● | ● | ● | ● | ● | ● | ● | ● | ● | ● | ● | ● | ● | ● | ● | ● | ● | ● | ● | ● | ● | ● | ● |
| 1 – 10 s | ● | ● | ● | ● | ● | ● | ● | ● | ● | ● | ● | ● | ● | ● | ● | ● | ● | ● | ● | ● | ● | ● | ● | ● | ● | ● | ● | ● | ● | ● | ● |
| 3 – 30 s | | | | | | | | | | | | ● | ● | ● | ● | ● | ● | ● | ● | ● | ● | ● | ● | ● | ● | | | | | | |
| 0.1 – 1 min | ● | ● | ● | ● | ● | ● | ● | ● | ● | ● | ● | ● | ● | ● | ● | ● | ● | ● | ● | ● | ● | ● | ● | ● | ● | ● | ● | ● | ● | ● | ● |
| 1 – 10 min | ● | ● | ● | ● | ● | ● | ● | ● | ● | ● | ● | ● | ● | ● | ● | ● | ● | ● | ● | ● | ● | ● | ● | ● | ● | ● | ● | ● | ● | ● | ● |
| 3 – 30 min | | | | | | | | | | | | ● | ● | ● | ● | ● | ● | ● | ● | ● | ● | ● | ● | ● | ● | | | | | | |
| 0.1 – 1 h | ● | ● | ● | ● | ● | ● | ● | ● | ● | ● | ● | ● | ● | ● | ● | ● | ● | ● | ● | ● | ● | ● | ● | ● | ● | ● | ● | ● | ● | ● | ● |
| 1 – 10 h | ● | ● | ● | ● | ● | ● | ● | ● | ● | ● | ● | ● | ● | ● | ● | ● | ● | ● | ● | ● | ● | ● | ● | ● | ● | ● | ● | ● | ● | ● | ● |
| 3 – 30 h | | | | | | | | | | | | ● | ● | ● | ● | ● | ● | ● | ● | ● | ● | ● | ● | ● | ● | | | | | | |
| 0.1 – 1 d | | ● | ● | ● | ● | ● | ● | ● | ● | ● | ● | | | | | | | | | | | | | | ● | ● | ● | ● | ● | ● | |
| 1 – 10 d | | ● | ● | ● | | | | | | | | | | | | | | | | | | | | | | | | | | | |
| 10 – 100 h | | | | | ● | ● | ● | ● | ● | ● | ● | ● | ● | ● | ● | ● | ● | ● | ● | ● | ● | ● | ● | ● | ● | ● | ● | ● | ● | ● | |
| 3 – 30 d | | | | | ● | ● | ● | ● | ● | ● | ● | | | | | | | | | | | | | | ● | ● | ● | ● | ● | ● | |
| 10 – 100 d | | | | | | | | | | | ● | | | | | | | | | | | | | | ● | | | | | | |
| 0.5 – 10 min | | | | | | | | | | | | | | | | | | | | | | | | | | | | | | | |
| 0.01s – 100 h | | | | | | | | | | | | | | | | | | | | | | | | | | | | | | | |
| 0.1s – 999 h | | | | | | | | | | | | | | | | | | | | | | | | | | | | | | | |
| Supply voltage | | | | | | | | | | | | | | | | | | | | | | | | | | | | | | | |
| AC 230 V | | □ | □ | □ | | | | | | | ● | | | | | | | | | | | | | ● | | | | | | | |
| AC/DC 12–240 V | ● | ● | ● | ● | ● | ● | ● | ● | ● | ● | ● | ● | ● | ● | ● | ● | ● | ● | ● | ● | ● | ● | ● | ● | ● | ● | ● | ● | ● | ● | |
| AC 24–240 V, DC 24 V | ● | | | | | | | | | | | | | | | | | | | | | | | | | | | | | | |
| AC/DC 24–240 V | | | | | | | | | | | | | | | | | | | | | | | | | | | | | | | |
| Output contact | | | | | | | | | | | | | | | | | | | | | | | | | | | | | | | |
| 1x changeover 8 A | ● | | | | | | | | | | | | | | | | | | | | | | | | | | | | | | |
| 1x changeover 16 A | | ● | | ● | | ● | ● | ● | ● | ● | ● | ● | ● | ● | | | | | | | | | | ● | | | | | | | |
| 2x changeover 8 A | | | | | | | | | | ● | | | | | | | | | | | | | | | | | | | | | |
| 2x changeover 16 A | | | ● | | | | | | | | | | | | ● | ● | ● | ● | | | | | | | ● | ● | ● | ● | ● | ● | |
| 1x switching 16 A | | | | | | | | | | | | | | | | | | | | | | | | | | | | | | | |
| 1x changeover 16 A, 2x changeover 8 A | | | ● | | ● | ● | | | | | | | | | | | | | | ● | ● | ● | ● | | | | | | | | |
| Solid state (triac) | | | | | | | | | | | | | | | | | | | | | | | | | | | | | | | |

only for CRM-91H, CRM-93H □
 with the option of extending it to 30 min ■

| | CRM-161 | CRM-91H | CRM-92H | CRM-93H | CRM-111H | CRM-112H | CRM-113H | CRM-121H | CRM-131H | CRM-82TO | CRM-2T | CRM-181JZR | CRM-181JZN | CRM-181JBL | CRM-181JOD | CRM-182JZR | CRM-182JZN | CRM-182JBL | CRM-182JOD | CRM-183JZR | CRM-183JZN | CRM-183JBL | CRM-183JOD | CRM-2H | PTRM-216x | PTRA-216x |
|--|---------|---------|---------|---------|----------|----------|----------|----------|----------|----------|--------|------------|------------|------------|------------|------------|------------|------------|------------|------------|------------|------------|------------|--------|-----------|-----------|
| Functions | | | | | | | | | | | | | | | | | | | | | | | | | | |
| Staircase switch | | | | | | | | | | | | | | | | | | | | | | | | | | |
| Programmable staircase switch (with/without signaling) | | | | | | | | | | | | | | | | | | | | | | | | | | |
| Delayed start | ● | ● | ● | ● | ● | ● | ● | ● | ● | ● | ● | ● | ● | ● | ● | ● | ● | ● | ● | ● | ● | ● | ● | ● | ● | ● |
| Delayed start with delay suppression | | | | ● | ● | ● | ● | ● | ● | | ● | | | ● | | ● | | | ● | | ● | | | | ● | ● |
| Delayed start after switching on the control contact | ● | | | | | | | | | | | | | | | | | | | | | | | | | |
| Delayed start after opening of the control contact | | | | | | | | | | | | | | | | | | | | | | | | | | |
| Delayed start after closing and delayed return after opening the control contact | | ● | ● | ● | ● | ● | ● | ● | ● | ● | ● | | | | | | | | | | | | | | ● | ● |
| Delayed start (repeatable) until the power is turned off | | | | | | | | | | | | | | | | | | | | | | | | | | |
| Delayed start star / triangle | | | | | | | | | | ● | | | | | | | | | | | | | | | | |
| 2x delayed start | | | | | | | | | | | | | | | | | | | | | | | | | | |
| Delayed return | ● | ● | ● | ● | ● | ● | ● | ● | ● | ● | ● | ● | ● | ● | ● | ● | ● | ● | ● | ● | ● | ● | ● | ● | ● | ● |
| Delayed return with delay suppression | | | | ● | ● | ● | ● | ● | ● | | | ● | | | ● | | | ● | | ● | | | | ● | ● | |
| Delay off on downward edge | | | | | | | | | | | | | | | | | | | | | | | | | | |
| TRUE OFF DELAY | | | | | | | | | | | | | | | | | | | | | | | | | | |
| TRUE SINGLE SHOT | | | | | | | | | | | | | | | | | | | | | | | | | | |
| TRUE INTERVAL ON | | | | | | | | | | | | | | | | | | | | | | | | | | |
| TRUE INTERVAL ON/OFF | | | | | | | | | | ● | | | | | | | | | | | | | | | | |
| Delayed return after closing the control contact | | ● | ● | ● | ● | ● | ● | ● | ● | ● | ● | | | | | | | | | | | | | ● | ● | ● |
| Delayed return after opening the control contact | | ● | ● | ● | | | | | | | | | | | | | | | | | | | | | | |
| Delayed return after opening the control contact with immediate closing of the output | ● | ● | ● | ● | ● | ● | ● | ● | ● | ● | ● | | | ● | | | ● | | | | ● | | | ● | ● | ● |
| Delayed return after closing the control contact - renewable | | | | | ● | ● | ● | ● | ● | ● | ● | | | | | | | | | | | | | ● | ● | ● |
| Delayed return after closing and opening of the control contact | | | | | ● | ● | ● | ● | ● | ● | ● | | | | | | | | | | | | | ● | ● | ● |
| Delayed return when closing the control contact with delayed output | | | | | | | | | | | | | | | | | | | | | | | | | | |
| Emergency light tester | | | | | | | | | | | | | | | | | | | | | | | | | | |
| Flasher 1:1 starting with an impulse | ● | ● | ● | ● | ● | ● | ● | ● | ● | ● | ● | ● | ● | ● | ● | ● | ● | ● | ● | ● | ● | ● | ● | ● | ● | ● |
| Flasher 1:1 starting with a delay-suppressed impulse | | | | | | | | | | | | ● | | | ● | | | ● | | ● | | | ● | | | |
| Flasher 1:1 starting with an impulse while the control button is pressed | | | | | | | | | | | | | | | | | | | | | | | | | | |
| Flasher 1:1 starting with a gap | | ● | ● | ● | ● | ● | ● | ● | ● | ● | ● | | | | | | | | | | | | | ● | ● | ● |
| Flasher 1:1 starting with a gap while the control button is pressed | | | | | | | | | | | | | | | | | | | | | | | | | | |
| Asymmetric flasher starting with an impulse | | | | | | | | | | | | | | | | | | | | | | | | ● | | |
| Asymmetric flasher starting with a gap | | | | | | | | | | | | | | | | | | | | | | | | ● | | |
| Impulse relay | | ● | ● | ● | ● | ● | ● | ● | ● | ● | ● | | | | | | | | | | | | | ● | ● | |
| Impulse relay with delay | ● | | | | ● | ● | ● | ● | ● | ● | ● | | | | | | | | | | | | | | | ● |
| Pulse generator | | ● | ● | ● | ● | ● | ● | ● | ● | ● | ● | | | | | | | | | | | | | ● | ● | ● |
| Pulse generator with delay suppression | | | | | ● | ● | ● | ● | ● | ● | ● | | | | | | | | | | | | | ● | ● | |

● functions controlled by inputs START, INHIBIT, RESET

■ functions controlled by inputs START, STOP



EAN code
CRM-161: 8595188181617

Technical parameters CRM-161

Power supply

| | |
|---------------------------|---------------------------------------|
| Supply terminals: | A1 - A2 |
| Voltage range: | AC 24 - 240 V DC 24 V (AC 50-60 Hz) |
| Power input (max.): | 2 VA/1.5 W |
| Supply voltage tolerance: | -15 %; +10 % |
| Supply indication: | green LED |

Time circuit

| | |
|--------------------------|---|
| Number of functions: | 6 |
| Time ranges: | 0.1 s - 10 hrs |
| Time setting: | rotary switch and potentiometer |
| Time deviation: | 5 % - mechanical setting |
| Repeat accuracy: | 0.2 % - set value stability |
| Temperature coefficient: | 0.01 %/°C, at = 20 °C (0.01 %/°F, at = 68 °F) |

Output

| | |
|-------------------------|---|
| Number of contacts: | 1x changeover/SPDT (AgNi) |
| Current rating: | 8 A/AC1; 1/2 HP 240 Vac, 1/3 HP 120 Vac; PD. B300 |
| Breaking capacity: | 2000 VA/AC1, 192 W/DC |
| Switching voltage: | 250 V AC/24 V DC |
| Max. power dissipation: | 0.6 W |
| Output indication: | multifunction red LED |
| Mechanical life: | 10.000.000 ops. |
| Electrical life (AC1): | 100.000 ops. |

Control

| | |
|---------------------|---------------------------|
| Control. terminals: | A1-S |
| Load between S-A2: | Yes |
| Impulse length: | min. 25 ms/max. unlimited |
| Reset time: | max. 150 ms |

Other information

| | |
|-------------------------------------|---|
| Operating temperature: | -20 .. +55 °C (-4 .. 131 °F) |
| Storage temperature: | -30 .. +70 °C (-22 .. 158 °F) |
| Dielectric strength: | 4kV AC (supply - output) |
| Operating position: | any |
| Mounting: | DIN rail EN 60715 |
| Protection degree: | IP40 from front panel/IP20 terminals |
| Overvoltage category: | III. |
| Pollution degree: | 2 |
| Max. cable size (mm ²): | solid wire max. 1x 2.5 or 2x 1.5/ with sleeve max. 1x 2.5 (AWG 12) |
| Dimensions: | 90 x 17.6 x 64 mm (3.5" x 0.7" x 2.5") |
| Weight: | 62 g (2.2 oz.) |
| Standards: | EN 61812-1 |

- Multifunction economy version of time relay for universal use in automation, control and regulation or in house installations.
- Universal supply voltage: AC 24 – 240 V (AC 50/60 Hz) and DC 24 V.
- Comfortable and well-arranged function and time-range setting by rotary switches.
- Time scale 0.1 s - 10 hrs divided into 6 ranges: (0.1 s - 1 s/1 s - 10 s/0.1 min - 1 min/1 min - 10 min/0.1 hrs - 1 h/1 h - 10 hrs).
- Output contact: 1x changeover/SPDT 8 A.
- Multifunction red LED flashes or shines depending on the operating status.

Description

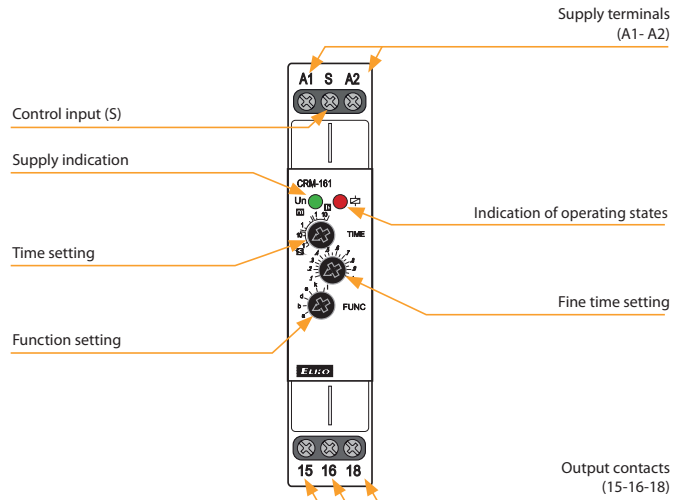

Functions

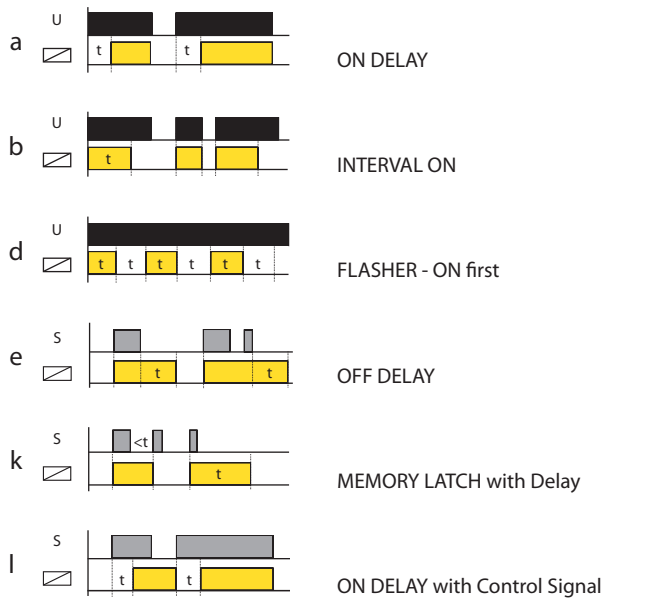

Connection

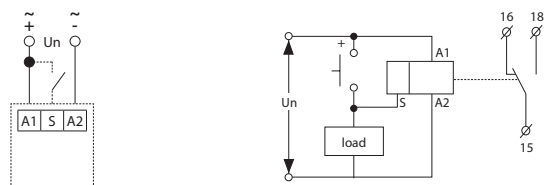

Possibility to connect load onto controlling input
 It is possible to connect the load (e.g.: contactor) between terminals S-A2, without any interruption of correct relay function.

Indication of operating states

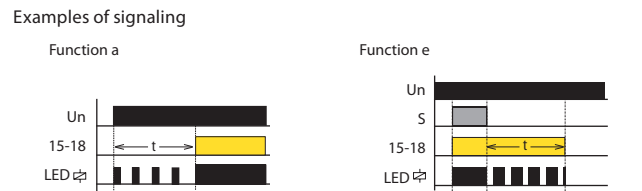



EAN code
 CRM-91H/UNI: 8595188112420
 CRM-92H/UNI: 8595188176897
 CRM-93H/UNI: 8595188112468

Technical parameters CRM-91H CRM-92H CRM-93H

Power supply

| | | | |
|---------------------------|--------------------------------|--------------|--------------|
| Supply terminals: | A1 - A2 | | |
| Voltage range: | AC/DC 12 - 240 V (AC 50-60 Hz) | | |
| Power input (max.): | 2 VA/1.5 W | 2.5 VA/1.5 W | 2.5 VA/1.5 W |
| Voltage range: | AC 230 V (50/60 Hz) | | |
| Power input (max.): | 3VA/1.4W | - | 4VA/2W |
| Supply voltage tolerance: | -15 %; +10 % | | |
| Supply indication: | green LED | | |

Time circuit

| | |
|--------------------------|---|
| Number of functions: | 10 |
| Time ranges: | 0.1 s - 10 days |
| Time setting: | rotary switch and potentiometer |
| Time deviation: | 5 % - mechanical setting |
| Repeat accuracy: | 0.2 % - set value stability |
| Temperature coefficient: | 0.01 %/°C, at = 20 °C (0.01 %/°F, at = 68 °F) |

Output

| | | | |
|---------------------------|--|--|----------------------------------|
| Number of contacts 1: | 1x changeover/SPDT (AgNi) | | |
| Current rating: | 16 A/AC1; 1 HP 240 Vac, 1/2 HP 120 Vac; PD. B300 | | |
| Breaking capacity: | 4000 VA/AC1, 384 W/DC | | |
| Electrical life (AC1): | 100.000 ops. | | |
| Number of contacts 2 (3): | x | 1x chang./SPDT (AgNi) | 2x chang./DPDT (AgNi) |
| Current rating: | x | 16 A/AC1; 1 HP 240 Vac, 1/2 HP 120 Vac; PD. B300 | 8 A/AC1; 1/2 HP 240Vac; PD. B300 |
| Breaking capacity: | x | 4000 VA/AC1, 384 W/DC | 2000 VA/AC1, 192 W/DC |
| Electrical life (AC1): | x | 100.000 ops. | 50.000 ops. |
| Switching voltage: | 250 V AC/24 V DC | | |
| Max. power dissipation: | 1.2 W | 2.4 W | 2.4 W |
| Mechanical life: | 10.000.000 ops. | | |

Control

| | |
|---------------------|---------------------------|
| Control. terminals: | A1-S |
| Load between S-A2: | Yes |
| Impulse length: | min. 25 ms/max. unlimited |
| Reset time: | max. 150 ms |

Other information

| | | | |
|-------------------------------------|---|------------------------|--|
| Operating temperature: | -20 .. +55 °C (-4 .. 131 °F) | | |
| Storage temperature: | -30 .. +70 °C (-22 .. 158 °F) | | |
| Dielectric strength: | supply - output 1 4kV AC | | |
| | x | 4kV AC | 1kV AC |
| | x | 4kV AC | 1kV AC |
| | x | x | 1kV AC |
| Operating position: | any | | |
| Mounting: | DIN rail EN 60715 | | |
| Protection degree: | IP40 front panel/IP20 terminals | | |
| Overvoltage category: | III. | | |
| Pollution degree: | 2 | | |
| Max. cable size (mm ²): | solid wire max. 1x 2.5 or 2x 1.5/ with sleeve max. 1x 2.5 (AWG 12) | | |
| Dimensions: | 90 x 17.6 x 64 mm (3.5" x 0.7" x 2.5") | | |
| Weight: | UNI - 62 g (2.2 oz) 230 - 57 g (2 oz) | UNI - 85 g (3 oz) - | UNI - 85 g (3 oz) 230 - 80 g (2.8 oz) |
| Standards: | EN 61812-1 | | |

- Multifunction time relay for universal use in automation, control and regulation or in house installations.
- Comfortable and well-arranged function and time-range setting by rotary switches.
- Multifunction red LED flashes or shines depending on the operating status.

Description

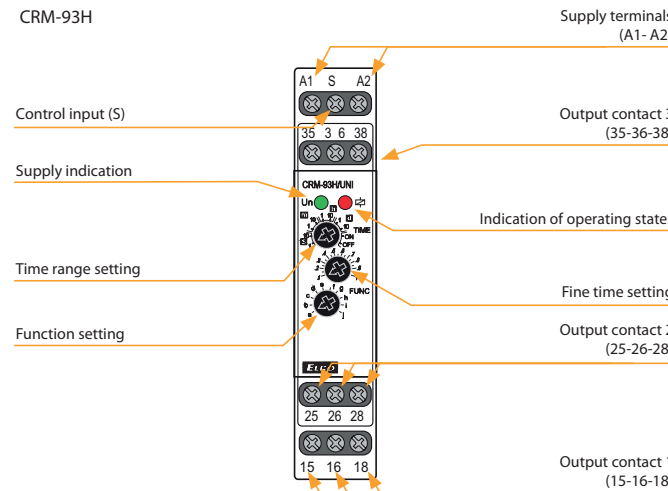

Connection

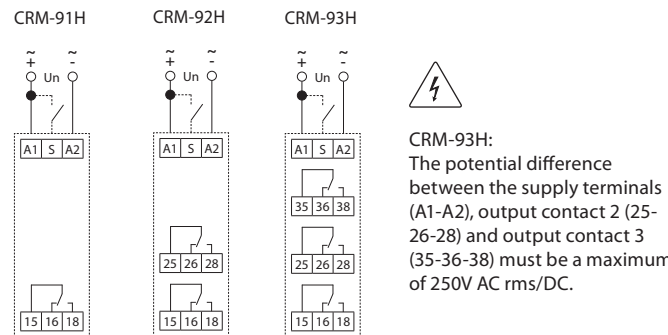

Possibility to connect load onto controlling input
 It is possible to connect the load (e.g.: contactor) between terminals S-A2, without any interruption of correct relay function.

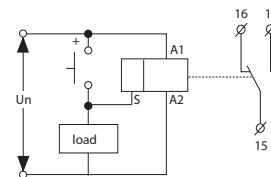

Indication of operating states

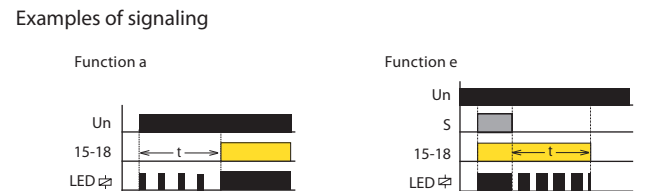

Function



ON DELAY

When the input voltage U is applied, timing delay t begins. Relay contacts R change state after time delay is complete. Contacts R return to their shelf state when input voltage U is removed. Trigger switch is not used in this function.



INTERVAL ON

When input voltage U is applied, relay contacts R change state immediately and timing cycle begins. When time delay is complete, contacts return to shelf state. When input voltage U is removed, contacts will also return to their shelfstate. Trigger switch is not used in this function.



FLASHER - OFF first

When input voltage U is applied, time delay t begins. When time delay t is complete, relay contacts R change state for time delay t. This cycle will repeat until input voltage U is removed. Trigger switch is not used in this function.



FLASHER - ON first

When input voltage U is applied, relay contacts R change state immediately and time delay t begins. When time delay t is complete, contacts return to their shelf state for time delay t. This cycle will repeat until input voltage U is removed. Trigger switch is not used in this function.

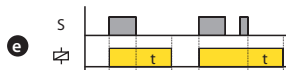

OFF DELAY

Input voltage U must be applied continuously. When trigger switch S is closed, relay contacts R change state. When trigger switch S is opened, delay t begins. When delay t is complete, contacts R return to their shelf state. If trigger switch S is closed before time delay t is complete, then time is reset. When trigger switch S is opened, the delay begins again, and relay contacts R remain in their energized state. If input voltage U is removed, relay contacts R return to their shelf state.

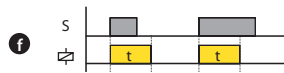

SINGLE SHOT

Upon application of input voltage U, the relay is ready to accept trigger signal S. Upon application of the trigger signal S, the relay contacts R transfer and the preset time t begins. During time-out, the trigger signal S is ignored. The relay resets by applying the trigger switch S when the relay is not energized.

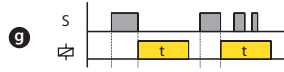

SINGLE SHOT falling edge

Upon application of input voltage U, the relay is ready to accept trigger signal S. Upon application of the trigger signal S, the relay contacts R transfer and the preset time t begins. At the end of the preset time t, the relay contacts R return to their normal condition unless the trigger switch S is opened and closed prior to time out t (before preset time elapses). Continuous cycling of the trigger switch S at a rate faster than the preset time will cause the relay contacts R to remain closed. If input voltage U is removed, relay contacts R return to their shelf state.

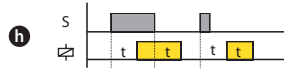

ON/OFF DELAY

Input voltage U must be applied continuously. When trigger switch S is closed, time delay t begins. When time delay t is complete, relay contacts R change state and remain transferred until trigger switch S is opened. If input voltage U is removed, relay contacts R return to their shelf state.

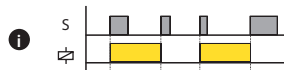

MEMORY LATCH

Input voltage U must be applied continuously. Output changes state with every trigger switch S closure. If input voltage U is removed, relay contacts R return to their shelf state.

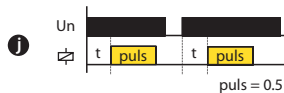

PULSE GENERATOR

Upon application of input voltage U, a single output pulse of 0.5 seconds is delivered to relay after time delay t. Power must be removed and reapplied to repeat pulse. Trigger switch is not used in this function.



EAN code
 CRM-111H/UNI: 8595188175548
 CRM-112H/UNI: 8595188175531
 CRM-113H/UNI: 8595188180634

Technical parameters CRM-111H CRM-112H CRM-113H

Power supply

| | | | |
|---------------------------|--------------------------------|--------------|--------------|
| Supply terminals: | A1-A2 | | |
| Supply voltage: | AC/DC 12 - 240 V (AC 50/60 Hz) | | |
| Consumption (max.): | 2 VA/1.5 W | 2.5 VA/1.5 W | 2.5 VA/1.5 W |
| Supply voltage tolerance: | -15 %; +10 % | | |
| Supply indication: | green LED | | |

Time circuit

| | | | |
|--------------------------|---|----|----|
| Number of functions: | 11 | 10 | 10 |
| Time ranges: | 50 ms – 30 days | | |
| Time setting: | rotary switches and potentiometers | | |
| Time deviation*: | 5 % – mechanical setting | | |
| Repeat accuracy: | 0.2 % – set value stability | | |
| Temperature coefficient: | 0.01 %/°C, at = 20 °C (0.01 %/°F, at = 68 °F) | | |

Output

| | | | |
|---------------------------|---------------------------|------------------------|------------------------|
| Contact type 1: | 1x changeover/SPDT (AgNi) | | |
| Current rating: | 16 A/AC1; PD. B300 | | |
| Breaking capacity: | 4000 VA/AC1, 384 W/DC1 | | |
| Electrical life (AC1): | 100.000 ops. | | |
| Contact type 2 (3): | x | 1x chang./SPDT (AgNi) | 2x chang./DPDT (AgNi) |
| Current rating: | x | 16 A/AC1; PD. B300 | 8 A/AC1; PD. B300 |
| Breaking capacity: | x | 4000 VA/AC1, 384 W/DC1 | 2000 VA/AC1, 192 W/DC1 |
| Electrical life (AC1): | x | 100.000 ops. | 50.000 ops. |
| Switching voltage: | 250V AC/24 V DC | | |
| Power dissipation (max.): | 1.2 W | 2.4 W | 2.4 W |
| Output indication: | multifunction red LED | | |
| Mechanical life: | 10.000.000 ops. | | |

Control

| | | | |
|--------------------|---------------------------|--|--|
| Control terminals: | A1-S | | |
| Load between S-A2: | Yes | | |
| Impulse length: | min. 25 ms/max. unlimited | | |
| Reset time: | max. 150 ms | | |

Other information

| | | | |
|--|--|--------------|--------------|
| Operating temperature: | -20 .. +55 °C (-4 .. 131 °F) | | |
| Storage temperature: | -30 .. +70 °C (-22 .. 158 °F) | | |
| Dielectric strength: | | | |
| supply – output 1 | AC 4 kV | | |
| supply – output 2 (3) | x | AC 4 kV | AC 1 kV |
| output 1 – output 2 | x | AC 4 kV | AC 1 kV |
| output 2 – output 3 | x | x | AC 1 kV |
| Operating position: | any | | |
| Mounting: | DIN rail EN 60715 | | |
| Protection degree: | IP40 front panel/IP20 terminals | | |
| Overvoltage category: | III. | | |
| Pollution degree: | 2 | | |
| Cross-wire section – solid/ stranded with ferrule (mm ²): | max. 1x 2.5 or 2x 1.5/ max. 1x 2.5 (AWG 12) | | |
| Dimensions: | 90 x 17.6 x 64 mm (3.5" x 0.7" x 2.5") | | |
| Weight: | 62 g (2.2 oz.) | 85 g (3 oz.) | 85 g (3 oz.) |
| Standards: | EN 61812-1 | | |

* for adjustable delay <100 ms, a time deviation of ± 10 ms applies

- Multifunction time relay for universal use in automation, control and regulation or in house installations.
- All functions initiated by the supply voltage, except for the flasher function, can use the control input to inhibit the delay (pause).
- Mode selection - according to the set function, permanently closed, permanently open, function of MEMORY LATCH with delay (CRM-111H)/switching of the second output contact according to supply voltage (CRM-113H).
- Multifunction red LED flashes or shines depending on the operating status.

Description

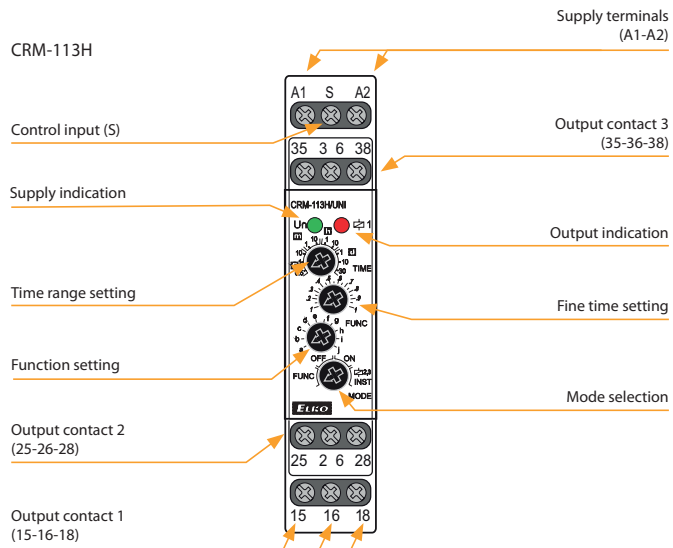

Connection

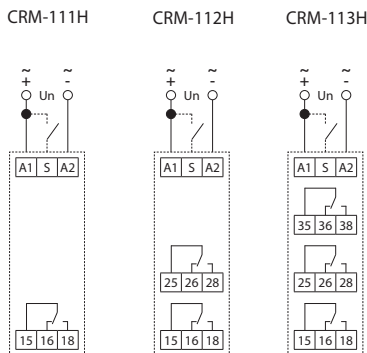

CRM-113H:
 The potential difference between the supply terminals (A1-A2), output contact 2 (25-26-28) and output contact 3 (35-36-38) must be a maximum of 250 V AC rms/DC.

Possibility to connect load onto controlling input

It is possible to connect the load (e.g.: contactor) between terminals S-A2, without any interruption of correct relay function.

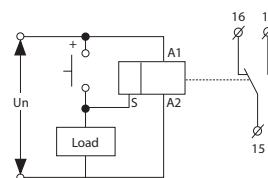

Indication of operating states

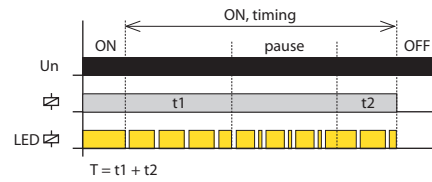
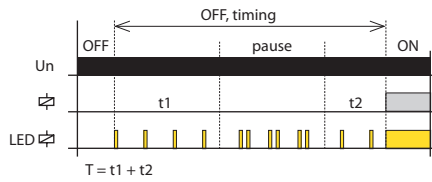

Mode selection

FUNC. Settings function mode

The desired function a-j is set with the FUNC rotary switch.

OFF. Output contact open mode



ON. Output contact closed mode



i Function: MEMORY LATCH with delay (Only for CRM-111H)



When the supply voltage is applied, the relay is open. If the control contact is closed, the relay closes and the time delay T starts. It does not matter the length of the control pulse. When the timing is complete, the relay opens. If the control contact is closed during timing, the relay opens immediately. Each time the control contact closes during relay timing, it changes status.

2,3 INST. Second or third output contact instantaneous (Only for CRM-112H, CRM-113H)



The second or third output contact switches according to the supply voltage. The first output contact switches according to the function (a-j) set by the trimmer FUNC.

Function

[Function \(page 17\).](#)



EAN code
CRM-121H/UNI: 8595188175555

Technical parameters

CRM-121H

Power supply

| | |
|---------------------------|--------------------------------|
| Supply terminals: | A1 - A2 |
| Voltage range: | AC/DC 12 - 240 V (AC 50-60 Hz) |
| Power input (max.): | 2 VA/1.5W |
| Supply voltage tolerance: | -15 %; +10 % |
| Supply indication: | green LED |

Time circuit

| | |
|--------------------------|---|
| Number of functions: | 11 |
| Time ranges: | 50 ms - 30 days |
| Time setting: | rotary switch and potentiometer |
| Time deviation:* | 5 % - mechanical setting |
| Repeat accuracy: | 0.2 % - set value stability |
| Temperature coefficient: | 0.01 %/°C, at = 20 °C (0.01 %/°F, at = 68 °F) |

Output

| | |
|-------------------------|--|
| Number of contacts | 1x changeover/SPDT (AgNi) |
| Current rating: | 16 A/AC1; 1 HP 240 Vac, 1/2 HP 120 Vac; PD. B300 |
| Breaking capacity: | 4000 VA/AC1, 384 W/DC |
| Switching voltage: | 250 V AC/24 V DC |
| Max. power dissipation: | 1.2 W |
| Output indication: | multifunction red LED |
| Mechanical life: | 10.000.000 ops. |
| Electrical life (AC1): | 100.000 ops. |

Control

| | |
|--------------------|---------------------------|
| Control terminals: | S1-S2 |
| Impulse length: | min. 25 ms/max. unlimited |
| Reset time: | max. 150 ms |

Other information

| | |
|-------------------------------------|---|
| Operating temperature: | -20 .. +55 °C (-4 .. 131 °F) |
| Storage temperature: | -30 .. +70 °C (-22 .. 158 °F) |
| Dielectric strength: | 4 kV AC (supply - output) |
| | 4 kV AC (supply - control input) |
| Operating position: | any |
| Mounting: | DIN rail EN 60715 |
| Protection degree: | IP40 from front panel/IP10 terminals |
| Overvoltage category: | III. |
| Pollution degree: | 2 |
| Max. cable size (mm ²): | solid wire max. 2x 2.5 or 1x 4/ with sleeve max. 1x 2.5 or 2x 1.5 (AWG 12) |
| Dimensions: | 90 x 17.6 x 64 mm (3.5" x 0.7" x 2.5") |
| Weight: | 72 g (2.5 oz.) |
| Standards: | EN 61812-1 |

* for adjustable delay <100 ms, a time deviation of ± 10 ms applies

- Multifunction time relay for universal use in automation, control and regulation or in house installations.
- Galvanically separated control input (Power Trigger).
- All functions initiated by the supply voltage, except for the flasher function, can use the control input to inhibit the delay (pause).
- Mode selection - according to the set function, permanently closed, permanently open, function of MEMORY LATCH with delay.
- Time scale 50 ms - 30 days divided into 10 ranges.
- Multifunction red LED flashes or shines depending on the operating status.

Description

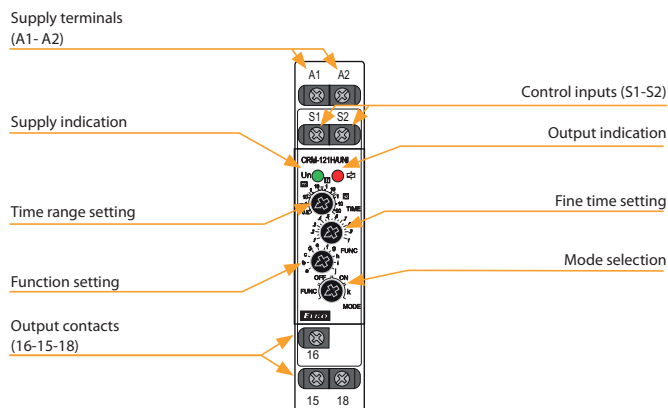

Connection

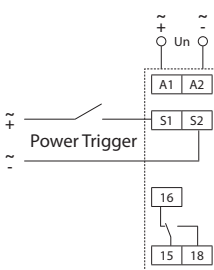

(Range of control voltage same as supply voltage)

Indication of operating states

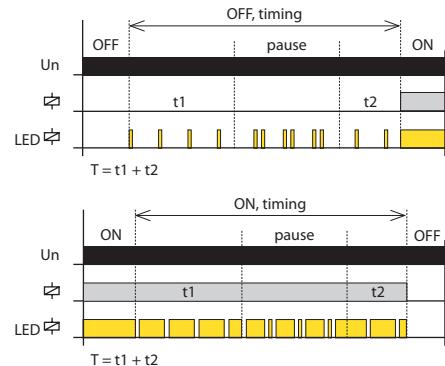

Mode selection

FUNC. Settings function mode

The desired function a-j is set with the FUNC rotary switch.

OFF. Output contact open mode



ON. Output contact closed mode



k. Function: MEMORY LATCH with delay



When the supply voltage is applied, the relay is open. If the control contact is closed, the relay closes and the time delay T starts. It does not matter the length of the control pulse. When the timing is complete, the relay opens. If the control contact is closed during timing, the relay opens immediately. Each time the control contact closes during relay timing, it changes status.

Function

a. ON DELAY



When the supply voltage is applied, the time delay T begins. When the timing is complete, the relay closes and this condition continues until the supply voltage is disconnected.

ON DELAY with Inhibit

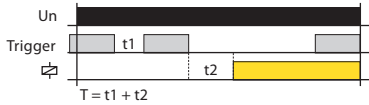

If the control contact is closed and the supply voltage is connected, the relay is opened and timing does not start until the control contact opens. When the timing is complete, the relay closes. If the control contact is closed during timing, the timing is interrupted and continues only after the control contact opens.

b. INTERVAL ON



After supply voltage relay closes and starts the delay time T. After the end of the timing relay opens and this state lasts until the supply voltage is disconnected.

INTERVAL ON with Inhibit

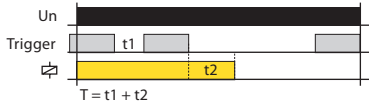

If the control contact is closed and the supply voltage is connected, the relay will close and the timing will start only after the control contact has been opened. When the timing is complete, the relay opens. If the control contact is closed during timing, the timing is interrupted and continues only after the control contact opens.

c. FLASHER - ON first



After supply voltage relay closes and starts the delay time T. After the end of the timing relay opens and again runs delay time T. When the timing is complete, the relay closes again and the sequence is repeated until the supply voltage is disconnected. If the control contact is closed during timing, this does not affect the operation of the cycler.

FLASHER - OFF first



If the control contact is closed during timing; this does not affect the operation of the cycler. If the control contact is closed and the supply voltage is connected, the cycler starts with a pause (relay open).

d. MEMORY LATCH

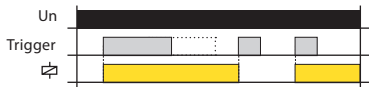

When the supply voltage is applied, the relay is open. When the control contact is closed, the relay closes. The status does not change when the control contact is opened. When the control contact is closed again, the relay opens. Each time the control contact is closed, the relay changes status.

e. OFF DELAY



When the supply voltage is applied, the relay is open. When the control contact is closed, the relay closes. When the control contact opens, the time delay T begins. If the control contact is closed during timing, the time is reset and the relay remains closed. When the control contact opens, the time delay T starts again and opens when the relay closes.

f. SINGLE SHOT

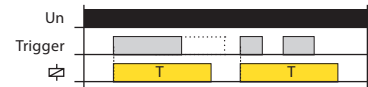

When the supply voltage is applied, the relay is open. When the control contact is closed, the relay closes and the time delay T begins. Closing the control contact during timing is ignored.

g. WATCHDOG



When the supply voltage is applied, the relay is open. When the control contact is closed, the relay closes and the time delay T begins. Closing the control contact during timing triggers a new time delay T - the relay closing time is thus increased.

h. PULSE GENERATOR 0.5 s

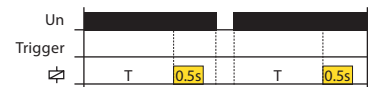

After the supply voltage has been applied, the time delay T begins. When the timing is complete, the relay closes for a fixed time (0.5 s).

PULSE GENERATOR 0.5 s with Inhibit

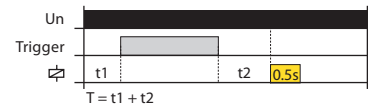

After supply voltage starts the time delay T. By closing timing of the control contact during timing is suspended. When the control contact opens, the time interval is completed and the relay closes for a fixed time (0.5 s).

i. INTERVAL ON/OFF

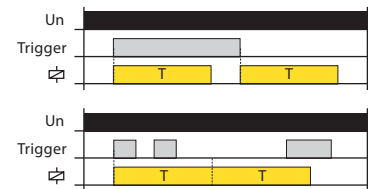

When the supply voltage is applied, the relay is open. When the control contact is closed, the relay closes and the time delay T begins. When the control contact is opened, the relay closes and the time delay T begins. If the control contact is open during timing, the relay remains closed for 2T. When the timing is complete, the relay opens. Any other change of control contact status during timing is ignored.

j. ON/OFF DELAY

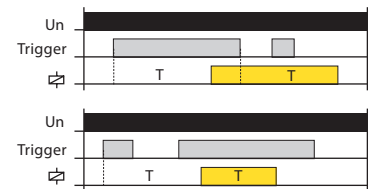

When the supply voltage is applied, the relay is open. If control contact is closed, time delay T starts. When the control contact is opened, a new time delay T begins. If the control contact is open during timing, the relay closes at the end of the timing and opens the relay after the new time delay. Any other change of control contact status during timing is ignored.



EAN code
CRM-131H/UNI: 8595188175562

Technical parameters

CRM-131H

Power supply

| | |
|---------------------------|--------------------------------|
| Supply terminals: | A1 - A2 |
| Voltage range: | AC/DC 12 - 240 V (AC 50-60 Hz) |
| Power input (max.): | 2 VA/1.5W |
| Supply voltage tolerance: | -15 %; +10 % |
| Supply indication: | green LED |

Time circuit

| | |
|--------------------------|---|
| Number of functions: | 11 |
| Time ranges: | 50 ms - 30 days |
| Time setting: | rotary switch and potentiometer |
| Time deviation:* | 5 % - mechanical setting |
| Repeat accuracy: | 0.2 % - set value stability |
| Temperature coefficient: | 0.01 %/°C, at = 20 °C (0.01 %/°F, at = 68 °F) |

Output

| | |
|-------------------------|--|
| Number of contacts | 1x changeover/SPDT (AgNi) |
| Current rating: | 16 A/AC1; 1 HP 240 Vac, 1/2 HP 120 Vac; PD. B300 |
| Breaking capacity: | 4000 VA/AC1, 384 W/DC |
| Switching voltage: | 250 V AC/24 V DC |
| Max. power dissipation: | 1.2 W |
| Output indication: | multifunction red LED |
| Mechanical life: | 10.000.000 ops. |
| Electrical life (AC1): | 100.000 ops. |

Control

| | |
|----------------------------|---------------------------|
| Load between I, S, R - A2: | Yes |
| Control terminals: | I, S, R - A1 |
| Impulse length: | min. 25 ms/max. unlimited |
| Reset time: | max. 150 ms |

Other information

| | |
|-------------------------------------|---|
| Operating temperature: | -20 .. +55 °C (-4 .. 131 °F) |
| Storage temperature: | -30 .. +70 °C (-22 .. 158 °F) |
| Dielectric strength: | 4 kV AC (supply - output) |
| Operating position: | any |
| Mounting: | DIN rail EN 60715 |
| Protection degree: | IP40 from front panel/IP20 terminals |
| Overvoltage category: | III. |
| Pollution degree: | 2 |
| Max. cable size (mm ²): | solid wire max. 1x 2.5 or 2x 1.5/ with sleeve max. 1x 2.5 (AWG 12) |
| Dimensions: | 90 x 17.6 x 64 mm (3.5" x 0.7" x 2.5") |
| Weight: | 61 g (2.2 oz.) |
| Standards: | EN 61812-1 |

* for adjustable delay <100 ms, a time deviation of ± 10 ms applies

- Multifunction time relay for universal use in automation, control and regulation or in house installations.
- Three control inputs - START, INHIBIT, RESET.
- Mode selection - according to the set function, permanently closed, permanently open, function of MEMORY LATCH with delay.
- Multifunction red LED flashes or shines depending on the operating status.

Description

Supply terminals
(A1 - A2)

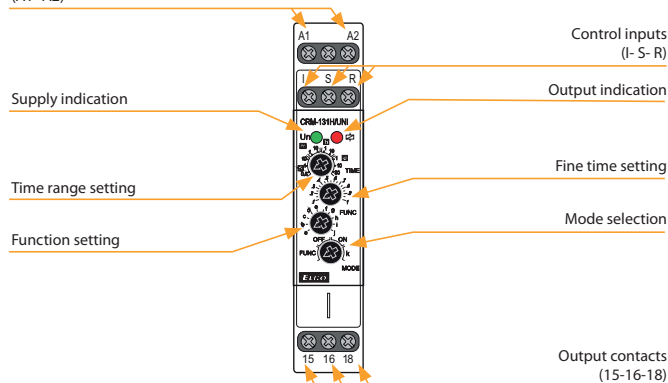

Connection

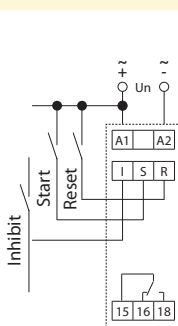

Indication of operating states

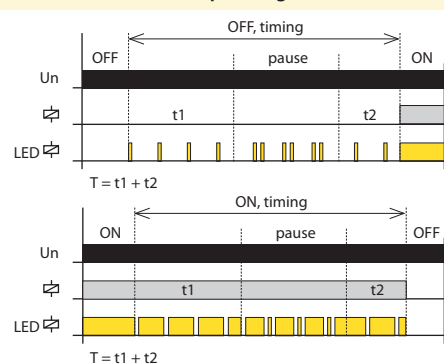

Mode selection

FUNC. Settings function mode

The desired function a-j is set with the FUNC rotary switch.

OFF. Output contact open mode



ON. Output contact closed mode



k. MEMORY LATCH with delay

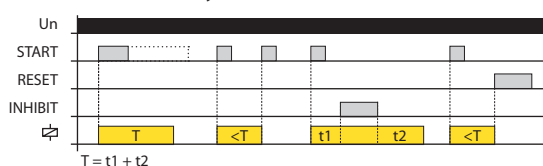

When the supply voltage is applied, the relay is open. If the START control contact is closed, the relay closes and the time delay T starts. It does not matter the length of the control pulse. When the timing is complete, the relay opens. If the START control contact is closed during timing, the relay opens immediately. Each time the control contact closes during relay timing, it changes status. Closing the INHIBIT control contact pauses the timing, after opening the INHIBIT control contact the timing continues from the moment of interruption. Closing the RESET control contact immediately ends the timing and the relay opens, just like as when the supply voltage is disconnected.

Function

Control input function description:

- Contact START starts the time function
- INHIBIT contact pauses timing (pause)
- The RESET contact simulates switching the supply voltage on and off

Same for all features:

- If the control contact START is closed and the supply voltage is connected, the time function is activated when the supply voltage is connected.
- Closing the control contact INHIBIT pauses the timing, after opening the control contact INHIBIT timing continues from the moment of interruption.
- If the INHIBIT control contact is closed, the START control contact is activated and the timing is paused.
- Closing the control contact RESET immediately terminates the timing and the relay opens, just as when the supply voltage is disconnected.
- If the control contact RESET is closed and then the control contact START is closed, the time function is activated when the control contact RESET is opened as well as when the supply voltage is connected.

a. ON DELAY with Control Signal

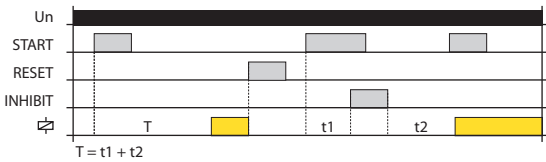

When the supply voltage is applied, the relay is open. If the control contact START is closed, the time delay T starts. The closing of the START control contact during timing is ignored.

b. INTERVAL ON with Control Signal

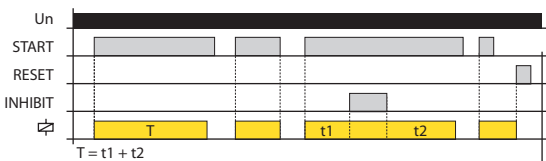

When the supply voltage is applied, the relay is open. When the control contact START is closed, the relay closes and the time delay T begins. If the START control contact is open during timing, the time interval is immediately terminated and the relay opens.

c. FLASHER - ON first with Control Signal

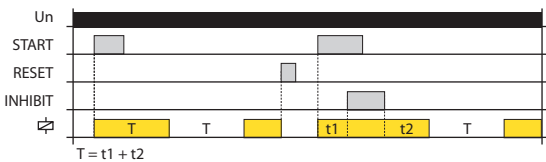

When the supply voltage is applied, the relay is open. When the START control contact is closed, the relay energizes and starts the delay time T. After the end of the timing relay opens and again runs delay time T. Upon completion timing again switches, and the sequence is repeated until the supply voltage is disconnected.

d. FLASHER - OFF first with Control Signal

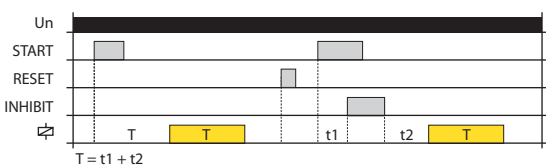

When the supply voltage is applied, the relay is open. When the START control contact is closed, starts the time delay T. After the end of the timing relay opens and the sequence is repeated until the supply voltage is disconnected.

e. OFF DELAY

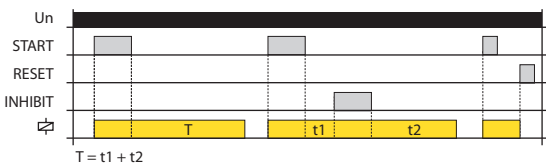

When the supply voltage is applied, the relay is open. If the control contact START is closed, the relay closes. After tripping Contact Start starts the delay time T. After the end of the timing relay is switched off.

f. SINGLE SHOT

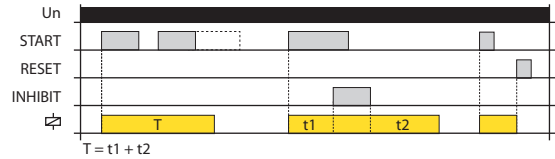

When the supply voltage is applied, the relay is open. When the START control contact is closed, the relay energizes and starts the delay time T. After the end of the timing relay is switched off. The closing of the START control contact during timing is ignored.

g. WATCHDOG

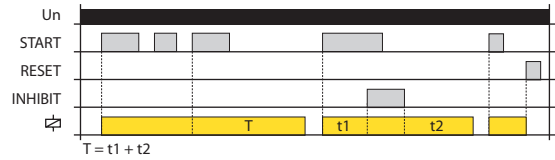

When the supply voltage is applied, the relay is open. When the START control contact is closed, the relay energizes and starts the delay time T. After the end of the timing relay is switched off. Closing control contact START during timing triggers a new time delay T - the relay closing time is thus increased.

h. PULSE GENERATOR 0.5 s with Control Signal

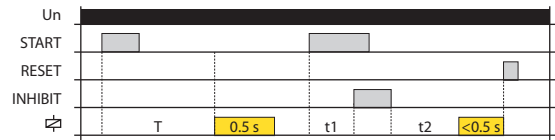

When the supply voltage is applied, the relay is open. When the START control contact is closed, starts the time delay T. After the end of the timing relay switches for the fixed time (0.5 sec).

i. INTERVAL ON/OFF

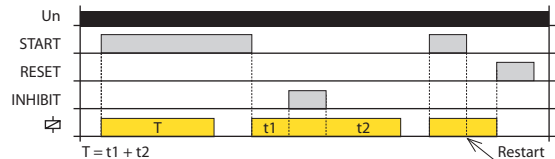

When the supply voltage is applied, the relay is open. When the START control contact is closed, the relay energizes and starts the delay time T. After the end of the timing relay is switched off. By opening the control contact start relay again closes and starts the delay time T. After the end of the timing relay is switched off.

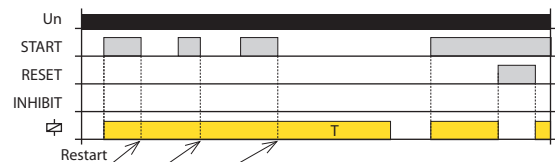

If the START control contact is open during timing, a restart occurs - the relay remains closed and a new time delay T begins. When the timing is complete, the relay opens.

j. ON/OFF DELAY

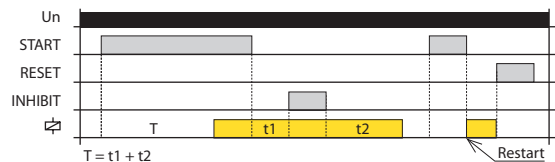

When the supply voltage is applied, the relay is open. When the START control contact is closed, starts the time delay T. After the end of the timing relay switches. Opening the control contact START starts a new time delay T. When the timing is complete, the relay opens.

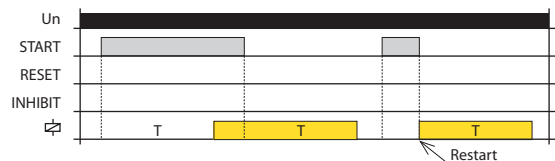

If the START control contact is open during timing, a restart occurs - the relay closes and a new time delay T begins. When the timing is complete, the relay opens.



EAN code
CRM-82TO/UNI: 8595188137614

Technical parameters

CRM-82TO

| | |
|--|---|
| Number of functions: | a - TRUE OFF DELAY / e - ON DELAY |
| Supply terminals: | A1 - A2 |
| Voltage range: | AC/DC 12 - 240 V (AC 50-60 Hz) |
| Burden (max.): | 3 VA / 1.7 W |
| Max. dissipated power (Un + terminals): | 2.5 W |
| Supply voltage tolerance: | -15 %; +10 % |
| Supply indication: | green LED |
| Time ranges: | 0.1 s - 10 min |
| Time setting: | potentiometer |
| Time deviation: | 5 % - mechanical setting |
| Repeat accuracy: | 0.2 % - set value stability |
| Temperature coefficient: | 0.1 %/°C, at = 20 °C (0.1 %/°F, at = 68 °F) |

Output

| | |
|------------------------|--|
| Number of contacts: | 2x changeover/DPDT (AgNi/Silver Alloy) |
| Current rating: | 8 A/AC1; 1/2 HP 240 Vac; PD. B300 |
| Breaking capacity: | 2000 VA/AC1, 192 W/DC |
| Inrush current: | 10 A/<3 s |
| Switching voltage: | 250 V AC/24 V DC |
| Output indication: | red LED |
| Mechanical life: | 2.000.000 ops. |
| Electrical life (AC1): | 200.000 ops. |

Other information

| | |
|-------------------------------------|---|
| Operating temperature: | -20 .. 55 °C (-4 .. 131 °F) |
| Storage temperature: | -30 .. 70 °C (-22 .. 158 °F) |
| Dielectric strength: | 4 kV (supply-output) |
| Operating position: | any |
| Mounting: | DIN rail EN 60715 |
| Protection degree: | IP40 from front panel / IP10 terminals |
| Overvoltage category: | III. |
| Pollution degree: | 2 |
| Max. cable size (mm ²): | solid wire max. 2x 2.5 or 1x 4, with sleeve max. 2x 1.5 or 1x 2.5 (AWG 12) |
| Dimensions: | 90 x 17.6 x 64 mm (3.5" x 0.7" x 2.5") |
| Weight: | 73 g (2.6 oz.) |
| Standards: | EN 61812-1 |

- „TRUE OFF DELAY“ relay starts timing after power supply failure. Example of use case: back-up source for DELAY OFF in case power supply failure. (e.g. emergency lighting, emergency respirator, or protection of el. controlled doors - in case of fire).
- 2 time functions adjustable by rotary switch:
a - delayed return after disconnecting of supply
e - delayed start.
- Time range (adjustable by rotary switch and fine setting by potentiometer): 0.1 s - 10 min.
- Interruptions in the power supply must take time steps (tens to hundreds of milliseconds).
- Output status indicated by red LED (only in case of supply voltage connection).

Description

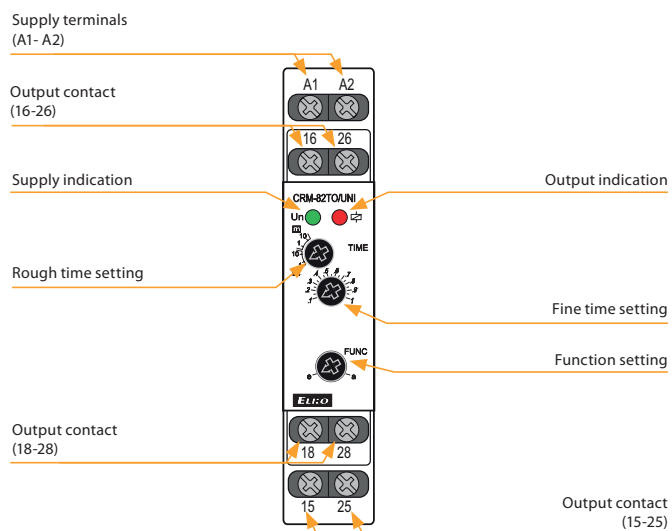

Function

a - TRUE OFF DELAY

e - ON DELAY

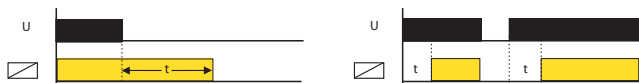

Connection

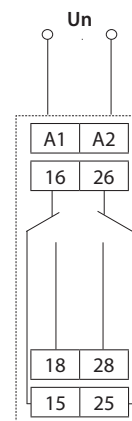

Symbol

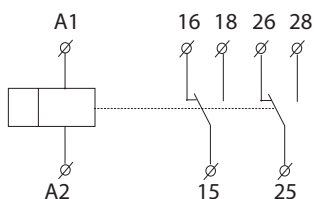



EAN code
CRM-2T/UNI: 8595188112437

Technical parameters CRM-2T

| Power supply | |
|---------------------------|--------------------------------|
| Supply terminals: | A1 - A2 |
| Voltage range: | AC/DC 12 - 240 V (AC 50-60 Hz) |
| Power input (max.): | 2 VA/1.5 W |
| Voltage range: | AC 230 V (50-60 Hz) |
| Power input (max.): | AC 3 VA/1.4 W |
| Supply voltage tolerance: | -15 %; +10 % |
| Supply indication: | green LED |

| Function | |
|--------------------------|---|
| Time scale: | t1: 0.1 s - 100 days; t2: 0.1 s - 1 s |
| Time setting: | rotary switch and potentiometer |
| Time deviation: | 5% - mechanical setting |
| Repeat accuracy: | 0.2 % - set value stability |
| Temperature coefficient: | 0.01 %/°C, at = 20 °C (0.01 %/°F, at = 68 °F) |

| Output | |
|-------------------------|--|
| Number of contacts: | 2x changeover/SPDT (AgNi) |
| Current rating: | 16 A/AC1; 1 HP 240 Vac, 1/2 HP 120 Vac; PD. B300 |
| Breaking capacity: | 4000 VA/AC1, 384 W/DC |
| Inrush current: | 30 A/< 3 s |
| Switching voltage: | 250 V AC/24 V DC |
| Max. power dissipation: | 1.2 W |
| Output indication: | multifunction red LED |
| Mechanical life: | 10.000.000 ops. |
| Electrical life (AC1): | 100.000 ops. |
| Reset time: | max. 150 ms |

| Other information | |
|--|--|
| Operating temperature: | -20 .. 55 °C (-4 .. 131 °F) |
| Storage temperature: | -30 .. 70 °C (-22 .. 158 °F) |
| Dielectric strength: | |
| supply - output 1 | 4 kV AC |
| supply - output 2 | 4 kV AC |
| output 1 - output 2 | 4 kV AC |
| Operating position: | any |
| Mounting: | DIN rail EN 60715 |
| Protection degree: | IP40 from front panel/IP20 terminals |
| Overvoltage category: | III. |
| Pollution degree: | 2 |
| Terminal wire capacity (mm ²): | max.1x 2.5, 2x1.5, with sleeve max. 1x 2.5 (AWG 12) |
| Dimensions: | 90 x 17.6 x 64 mm (3.5" x 0.7" x 2.5") |
| Weight: | UNI - 78 g (2.8 oz.), 230 - 73 g (2.6 oz.) |
| Standards: | EN 61812-1 |

Symbol

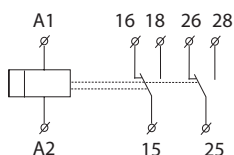

- It serves for delay ON of motors star/delta.
- Time t1 (star):
 - time range setting by rotary switch
 - fine time setting by potentiometer.
- Time t2 (delay) between λ/Δ
 - fine time setting by potentiometer.
- Multifunction red LED flashes or shines depending on the operating status.

Description

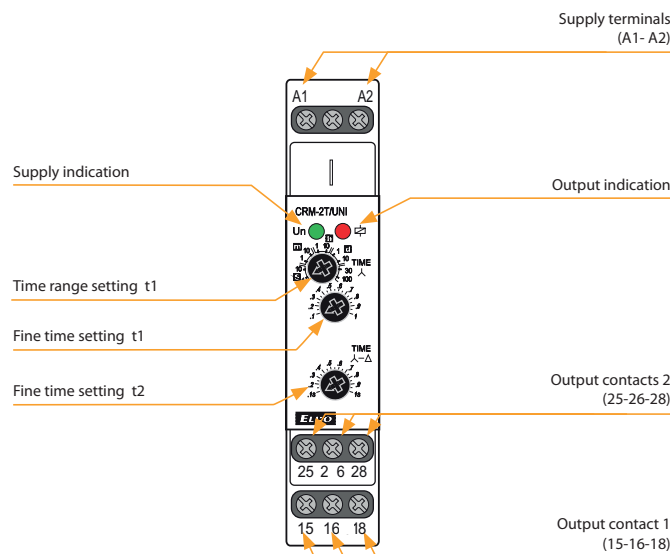

Function

STAR/DELTA timer

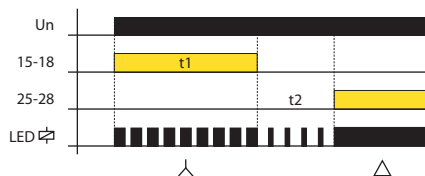

Connection

Start up of motor (λ - Δ)

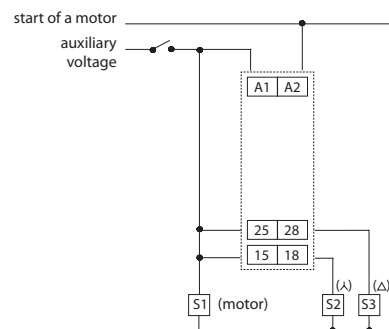
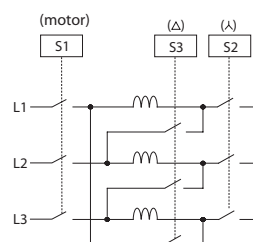



| EAN code | CRM-181J | CRM-182J | CRM-183J |
|--------------------------------|--------------------------------|--------------------------------|----------|
| CRM-181J/UNI ZR: 8595188180382 | CRM-182J/UNI ZR: 8595188176903 | CRM-183J/UNI ZR: 8595188180610 | |
| CRM-181J/UNI ZN: 8595188180399 | CRM-182J/UNI ZN: 8595188176910 | CRM-183J/UNI ZN: 8595188180603 | |
| CRM-181J/UNI BL: 8595188180405 | CRM-182J/UNI BL: 8595188176927 | CRM-183J/UNI BL: 8595188180580 | |
| CRM-181J/UNI OD: 8595188180412 | CRM-182J/UNI OD: 8595188176934 | CRM-183J/UNI OD: 8595188180597 | |

Technical parameters CRM-181J CRM-182J CRM-183J

Power supply

| | | | |
|---------------------------|--------------------------------|--------------|--------------|
| Supply terminals: | A1 - A2 | | |
| Voltage range: | AC/DC 12 - 240 V (AC 50-60 Hz) | | |
| Power input (max.): | 2 VA/1.5 W | 2.5 VA/1.5 W | 2.5 VA/1.5 W |
| Supply voltage tolerance: | -15 %; +10 % | | |
| Supply indication: | green LED | | |

Time circuit

| | | | |
|--------------------------|---|--|--|
| Time ranges: | 0.1 s - 100 h | | |
| Time setting: | rotary switch and potentiometer | | |
| Time deviation: | 5 % - mechanical setting | | |
| Repeat accuracy: | 0.2 % - set value stability | | |
| Temperature coefficient: | 0.01%/°C, at = 20 °C (0.01 %/°F, at = 68°F) | | |

Output

| | | | |
|-------------------------|--|--|----------------------------------|
| Output contact 1: | 1x changeover/SPDT (AgNi) | | |
| Current rating: | 16 A/AC1; 1 HP 240 Vac, 1/2 HP 120 Vac; PD. B300 | | |
| Breaking capacity: | 4000 VA/AC1, 384 W/DC1 | | |
| Electrical life (AC1): | 100.000 ops. | | |
| Output contact 2 (3): | x | 1x chang./SPDT (AgNi) | 2x chang./DPDT (AgNi) |
| Current rating: | x | 16 A/AC1; 1 HP 240 Vac, 1/2 HP 120 Vac; PD. B300 | 8 A/AC1; 1/2 HP 240Vac; PD. B300 |
| Breaking capacity: | x | 4000 VA/AC1, 384 W/DC1 | 2000 VA/AC1, 192 W/DC1 |
| Electrical life (AC1): | x | 100.000 ops. | 50.000 ops. |
| Switching voltage: | 250 V AC/24 V DC | | |
| Max. power dissipation: | 1.2 W | 2.4 W | 2.4 W |
| Mechanical life: | 10.000.000 ops. | | |

Control

| | | | |
|--------------------|---------------------------|--|--|
| Control terminals: | A1-S | | |
| Load between S-A2: | Yes | | |
| Impulse length: | min. 25 ms/max. unlimited | | |
| Reset time: | max. 150 ms | | |

Other information

| | | | |
|-------------------------------------|---|-------------|-------------|
| Operating temperature: | -20 .. +55 °C (-4 .. 131 °F) | | |
| Storage temperature: | -30 .. +70 °C (-22 .. 158 °F) | | |
| Dielectric strength: | | | |
| supply - output 1 | 4 kV AC | | |
| supply - output 2 (3) | x | 4 kV AC | 1 kV AC |
| output 1 - output 2 | x | 4 kV AC | 1 kV AC |
| output 2 - output 3 | x | x | 1 kV AC |
| Operating position: | any | | |
| Mounting: | DIN rail EN 60715 | | |
| Protection degree: | IP40 front panel/IP20 terminals | | |
| Overvoltage category: | III. | | |
| Pollution degree: | 2 | | |
| Max. cable size (mm ²): | solid wire max. 1x 2.5 or 2x 1.5/ with sleeve max. 1x 2.5 (AWG 12) | | |
| Dimensions: | 90 x 17.6 x 64 mm (3.5" x 0.7" x 2.5") | | |
| Weight: | 61 g (2.2 oz) | 84 g (3 oz) | 84 g (3 oz) |
| Standards: | EN 61812-1 | | |

- Single function time relays are suitable for applications where there is a clear function requirement in advance and are suitable for universal use in automation, control and regulation or in house installations.
- Choice of four types: ZR, ZN, BL, OD.
- All functions initiated by the supply voltage can use the control input to inhibit the ongoing delay (pause).
- Multifunction red LED flashes or shines depending on the operating status.

Description

CRM-183J

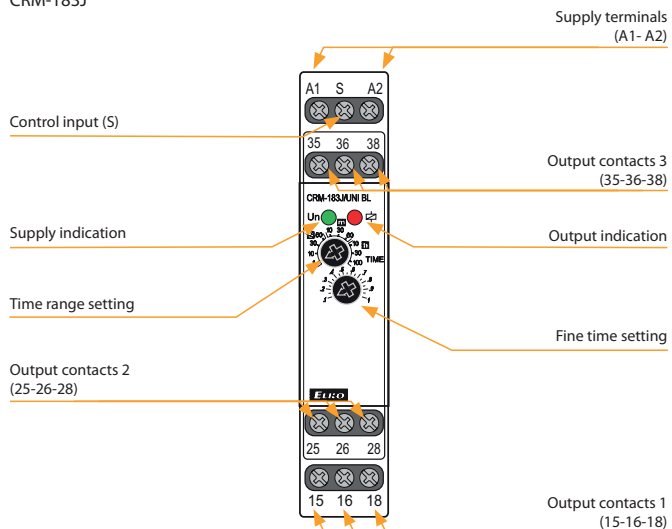

Connection

CRM-181J

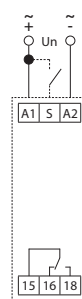

CRM-182J

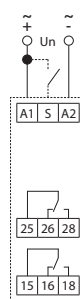

CRM-183J

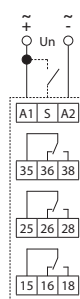

CRM-183J:
The potential difference between the supply terminals (A1-A2), output contact 2 (25-26-28) and output contact 3 (35-36-38) must be a maximum of 250 V AC rms/DC.

Possibility to connect load onto controlling input

It is possible to connect the load (e.g.: contactor) between terminals S-A2, without any interruption of correct relay function.

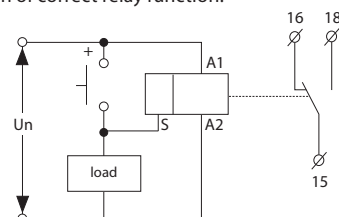

Indication of operating states

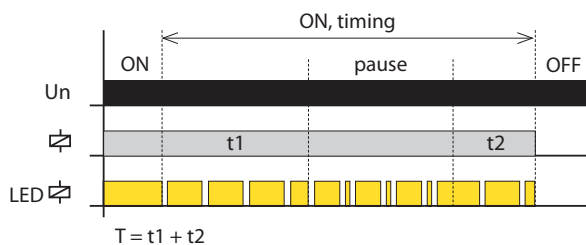
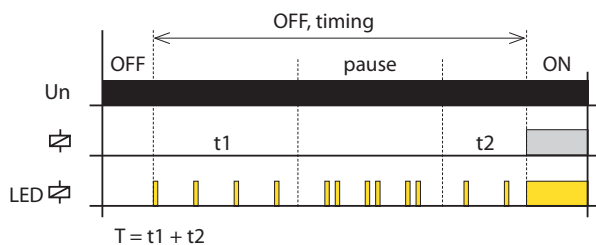

Function

ZR: ON DELAY



When the supply voltage is applied, the time delay T begins. When the timing is complete, the relay closes and this condition continues until the supply voltage is disconnected.

BL: FLASHER - ON first



If the control contact is closed and the supply voltage is connected, the relay will close and the timing will start only after the control contact has been opened. When the timing is complete, the relay opens.

ON DELAY with Inhibit

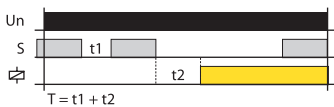

If the control contact is closed and the supply voltage is connected, the relay is opened and timing does not start until the control contact opens. When the timing is complete, the relay closes. If the control contact is closed during timing, the timing is interrupted and continues only after the control contact opens.

FLASHER - ON first with Inhibit

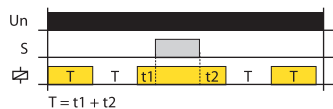

If the control contact is closed during an active timer setting, the timing is interrupted and continues only after the control contact opens again.

ZN: INTERVAL ON



After supply voltage relay closes and starts the delay time T. After the end of the timing relay opens and this state lasts until the supply voltage is disconnected.

OD: OFF DELAY



When the supply voltage is applied, the relay is open. When the control contact is closed, the relay closes. When the control contact opens, the time delay T begins. If the control contact is closed during timing, the time is reset and the relay remains closed. When the control contact opens, the time delay T starts again and opens when the relay closes.

INTERVAL ON with Inhibit

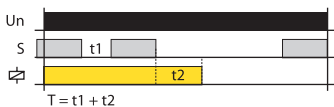

If the control contact is closed and the supply voltage is connected, the relay will close and the timing will start only after the control contact has been opened. When the timing is complete, the relay opens. If the control contact is closed during timing, the timing is interrupted and continues only after the control contact opens.

Note:

ZR, ZN and BL functions are initiated by connecting the supply voltage to the product, i.e. In the event of a failure and recovery of the supply voltage, the relay automatically performs 1 cycle.



EAN code
CRM-2H/UNI: 8595188113007

Technical parameters

CRM-2H

Power supply

| | |
|---------------------------|--------------------------------|
| Supply terminals: | A1 - A2 |
| Voltage range: | AC/DC 12 - 240 V (AC 50-60 Hz) |
| Power input (max.): | 2 VA/1.5 W |
| Voltage range: | AC 230 V (50/60 Hz) |
| Power input (max.): | AC 3 VA/1.4 W |
| Supply voltage tolerance: | -15 %; +10 % |
| Supply indication: | green LED |

Function

| | |
|--------------------------|---|
| Time scale: | 0.1 s - 100 days |
| Time setting: | rotary switch and potentiometer |
| Time deviation: | 5 % - mechanical setting |
| Repeat accuracy: | 0.2 % - set value stability |
| Temperature coefficient: | 0.01 %/°C, at = 20°C (0.01 %/°F, at = 68°F) |

Output

| | |
|-------------------------|--|
| Number of contacts: | 1x changeover/SPDT (AgNi) |
| Current rating: | 16 A/AC1; 1 HP 240 Vac, 1/2 HP 120 Vac; PD. B300 |
| Breaking capacity: | 4000 VA/AC1, 384 W/DC |
| Inrush current: | 30 A/< 3 s |
| Switching voltage: | 250 V AC/24 V DC |
| Max. power dissipation: | 1.2 W |
| Output indication: | multifunction red LED |
| Mechanical life: | 10.000.000 ops. |
| Electrical life (AC1): | 100.000 ops. |
| Reset time: | max. 150 ms |

Other information

| | |
|--|---|
| Operating temperature: | -20 .. 55 °C (-4 .. 131 °F) |
| Storage temperature: | -30 .. 70 °C (-22 .. 158 °F) |
| Dielectric strength: | 4 kV AC (supply - output) |
| Operating position: | any |
| Mounting: | DIN rail EN 60715 |
| Protection degree: | IP40 from front panel/IP20 terminals |
| Overvoltage category: | III. |
| Pollution degree: | 2 |
| Terminal wire capacity (mm ²): | solid wire max. 1x 2.5 or 2x 1.5/ with sleeve max. 1x 2.5 (AWG 12) |
| Dimensions: | 90 x 17.6 x 64 mm (3.5" x 0.7" x 2.5") |
| Weight | UNI - 61 g (2.2 oz.), 230 - 58 g (2 oz.) |
| Standards: | EN 61812-1 |

Symbol

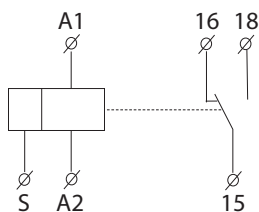

- Flasher with independent adjustable switch ON and switch OFF.
- Used for regular room ventilation, cyclic dehumidification, light control, circulating pumps, illuminated advertising, etc.
- 2 time functions:
 - 1) Asymmetric FLASHER - ON first
 - 2) Asymmetric FLASHER - OFF first
- Function choice is done by an external jumper of terminals S-A1.
- Time scale 0.1 s - 100 days divided into 10 time ranges.
- Time range setting via rotary switch.
- Fine time setting by potentiometer.
- Multifunction red LED flashes or shines depending on the operating status.

Description

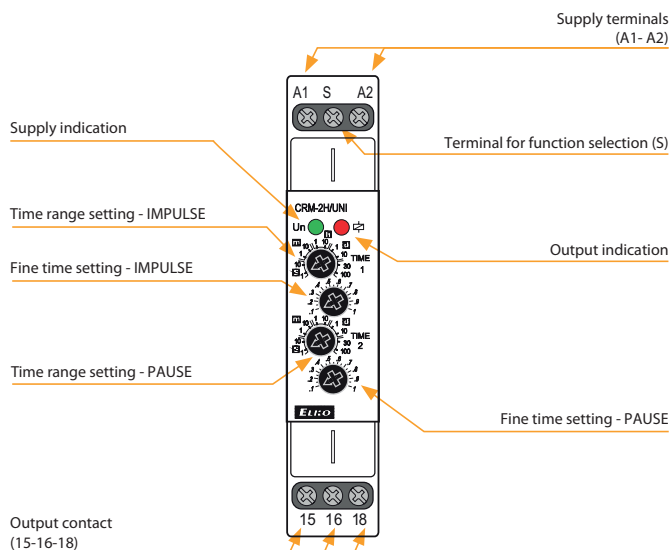

Connection

Asymmetric FLASHER - ON first

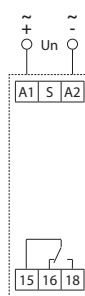

Asymmetric FLASHER - OFF first (jumper S-A1)



Function

Asymmetric FLASHER - ON first

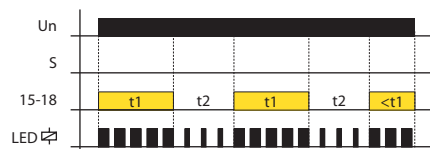

Asymmetric FLASHER - OFF first

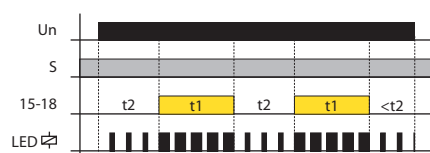

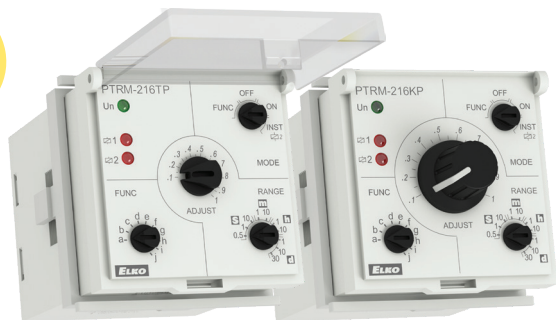

EAN code
PTRM-216TP/UNI: 8595188179386
PTRM-216KP/UNI: 8595188178617

Technical parameters PTRM-216TP PTRM-216KP

Power supply

| | |
|---------------------------|--------------------------------|
| Power pins: | 2, 10 |
| Voltage range: | AC/DC 12 – 240 V (AC 50-60 Hz) |
| Power input (max.): | 2.5 VA/1.5 W |
| Supply voltage tolerance: | ±10 % |
| Supply indication: | green LED |

Time circuit

| | |
|--------------------------|---|
| Number of functions: | 10 |
| Time ranges: | 50 ms - 30 days |
| Time setting: | rotary switch and potentiometer |
| Time deviation*: | 5 % - mechanical setting |
| Repeat accuracy: | 0.2 % - set value stability |
| Temperature coefficient: | 0.01 %/°C, at = 20 °C (0.01 %/°F, at = 68 °F) |

Output

| | |
|-------------------------|--|
| Number of contacts: | 2x changeover/SPDT (AgNi) |
| Current rating: | 16 A/AC1; 1 HP 240 Vac, 1/2 HP 120 Vac; PD. B300 |
| Breaking capacity: | 4000 VA/AC1, 384 W/DC |
| Switching voltage: | 250 V AC/24 V DC |
| Max. power dissipation: | 2.4 W |
| Output indication: | multifunction red LED |
| Mechanical life: | 10.000.000 ops. |
| Electrical life (AC1): | 100.000 ops. |

Control

| | |
|-----------------|---------------------------|
| Control pins: | 5 (2) -6 |
| Impulse length: | min. 25 ms/max. unlimited |
| Reset time: | max. 150 ms |

Other information

| | | |
|------------------------|-------------------------------|-------------------------------|
| Operating temperature: | -20 .. +55 °C (-4 .. 131 °F) | |
| Storage temperature: | -30 .. +70 °C (-22 .. 158 °F) | |
| Dielectric strength: | supply - output 1 (1, 3, 4) | 2.5 kV AC |
| | supply - output 2 (8, 9, 11) | 2.5 kV AC |
| | output 1 - output 2 | 2.5 kV AC |
| Operating position: | any | |
| Mounting: | 11 pin octal socket | |
| Protection degree: | IP40 from front panel | |
| Overvoltage category: | for supply voltage | 12-150 V AC/DC |
| | | III. |
| | for supply voltage | 150-240 V AC/DC |
| | II. | |
| Pollution degree: | 2 | |
| Dimensions: | 48x48x79mm (1.7" x1.7" x3.1") | 48x48x89mm (1.7" x1.7" x3.5") |
| Weight: | 111 g (3.9 oz.) | 108 g (3.81 oz.) |
| Standards: | EN 61812-1 | |

* for adjustable delay <100 ms, a time deviation of ± 10 ms applies

Function

Functions (page 26).

- Multifunction time relay for universal use in automation, control and regulation or in house installations.
- Possibility to select the control element for fine time setting: PTRM-216KP - knob, for easy handling without the need for tools PTRM-216TP - rotary switch, for the possibility of using a sealable cover.
- All functions initiated by the supply voltage, except for the flasher function, can use the control input to inhibit the delay (pause).
- Mode selection - according to the set function, permanently closed, permanently open, and switching of the second output contact according to the supply voltage.
- Multifunction red LED flashes or shines depending on the operating status.

Description

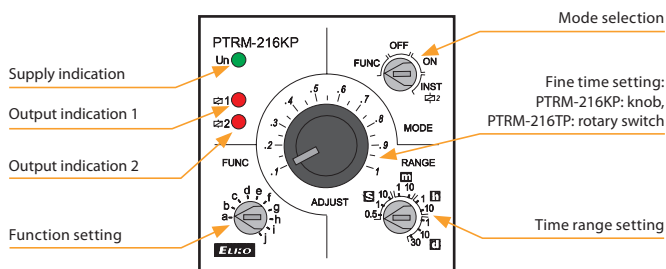

Connection **Indication of operating states**

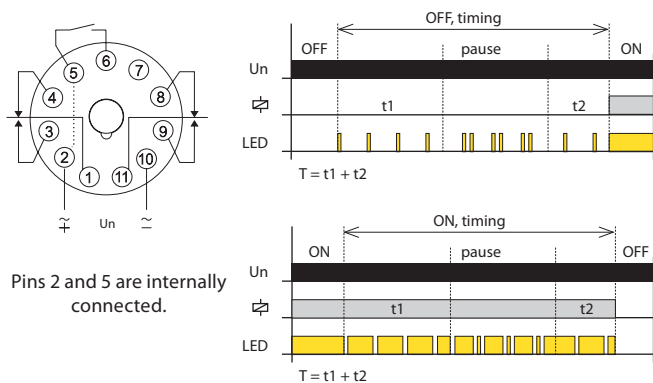

Mode selection

FUNC. Settings function mode
The desired function a-j is set with the FUNC rotary switch.

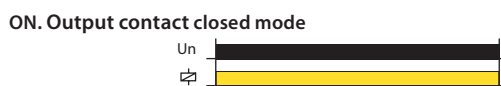
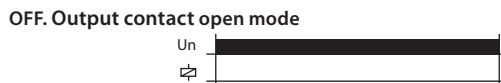

The second output contact switches according to the supply voltage. The first output contact switches according to the function (a-j) set by the trimmer FUNC.

Function

a. ON DELAY



When the supply voltage is applied, the time delay T begins. When the timing is complete, the relay closes and this condition continues until the supply voltage is disconnected.

ON DELAY with Inhibit

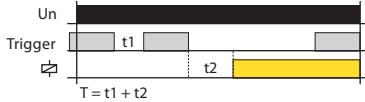

If the control contact is closed and the supply voltage is connected, the relay is opened and timing does not start until the control contact opens.

When the timing is complete, the relay closes. If the control contact is closed during timing, the timing is interrupted and continues only after the control contact opens.

b. INTERVAL ON



After supply voltage relay closes and starts the delay time T. After the end of the timing relay opens and this state lasts until the supply voltage is disconnected.

INTERVAL ON with Inhibit

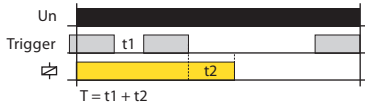

If the control contact is closed and the supply voltage is connected, the relay will close and the timing will start only after the control contact has been opened.

When the timing is complete, the relay opens. If the control contact is closed during timing, the timing is interrupted and continues only after the control contact opens.

c. FLASHER - ON first



After supply voltage relay closes and starts the delay time T. After the end of the timing relay opens and again runs delay time T. When the timing is complete, the relay closes again and the sequence is repeated until the supply voltage is disconnected. If the control contact is closed during timing, this does not affect the operation of the cycler.

FLASHER - OFF first



If the control contact is closed during timing; this does not affect the operation of the cycler. If the control contact is closed and the supply voltage is connected, the cycler starts with a pause (relay open).

d. MEMORY LATCH



When the supply voltage is applied, the relay is open. When the control contact is closed, the relay closes. The status does not change when the control contact is opened. When the control contact is closed again, the relay opens. Each time the control contact is closed, the relay changes status.

e. OFF DELAY



When the supply voltage is applied, the relay is open. When the control contact is closed, the relay closes. When the control contact opens, the time delay T begins. If the control contact is closed during timing, the time is reset and the relay remains closed. When the control contact opens, the time delay T starts again and opens when the relay closes.

f. SINGLE SHOT



When the supply voltage is applied, the relay is open. When the control contact is closed, the relay closes and the time delay T begins. Closing the control contact during timing is ignored.

g. WATCHDOG



When the supply voltage is applied, the relay is open. When the control contact is closed, the relay closes and the time delay T begins. Closing the control contact during timing triggers a new time delay T - the relay closing time is thus increased.

h. PULSE GENERATOR 0.5 s

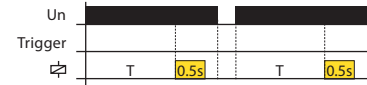

After the supply voltage has been applied, the time delay T begins. When the timing is complete, the relay closes for a fixed time (0.5 s).

PULSE GENERATOR 0.5 s with Inhibit

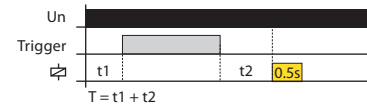

After supply voltage starts the time delay T. By closing timing of the control contact during timing is suspended. When the control contact opens, the time interval is completed and the relay closes for a fixed time (0.5 s).

i. INTERVAL ON/OFF

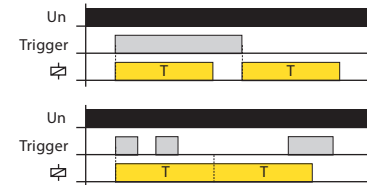

When the supply voltage is applied, the relay is open. When the control contact is closed, the relay closes and the time delay T begins. When the control contact is opened, the relay closes and the time delay T begins. If the control contact is open during timing, the relay remains closed for 2T. When the timing is complete, the relay opens. Any other change of control contact status during timing is ignored.

j. ON/OFF DELAY

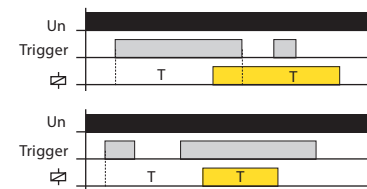

When the supply voltage is applied, the relay is open. If control contact is closed, time delay T starts. When the control contact is opened, a new time delay T begins. If the control contact is open during timing, the relay closes at the end of the timing and opens the relay after the new time delay. Any other change of control contact status during timing is ignored.



EAN code
PTRM-216T/UNI: 8595188175586
PTRM-216K/UNI: 8595188175579

| Technical parameters | PTRM-216T | PTRM-216K |
|------------------------------|--|-----------------------------|
| Power supply | | |
| Power pins: | 2, 10 | |
| Voltage range: | AC/DC 12 – 240 V (AC 50-60 Hz) | |
| Power input (max.): | 2.5 VA/1.5 W | |
| Supply voltage tolerance: | ±10 % | |
| Supply indication: | green LED | |
| Time circuit | | |
| Number of functions: | 10 | |
| Time ranges: | 50 ms – 30 days | |
| Time setting: | rotary switch and potentiometer | |
| Time deviation*: | 5 % - mechanical setting | |
| Repeat accuracy: | 0.2 % - set value stability | |
| Temperature coefficient: | 0.01 %/°C, at = 20 °C (0.01 %/°F, at = 68 °F) | |
| Output | | |
| Number of contacts: | 2x changeover/SPDT (AgNi) | |
| Current rating: | 16 A/AC1; 1 HP 240 Vac, 1/2 HP 120 Vac; PD. B300 | |
| Breaking capacity: | 4000 VA/AC1, 384 W/DC | |
| Switching voltage: | 250 V AC/24 V DC | |
| Max. power dissipation: | 2.4 W | |
| Output indication: | multifunction red LED | |
| Mechanical life: | 10.000.000 ops. | |
| Electrical life (AC1): | 100.000 ops. | |
| Control | | |
| Control pins: | 5 - 6 | |
| Impulse length: | min. 25 ms/max. unlimited | |
| Reset time: | max. 150 ms | |
| Other information | | |
| Operating temperature: | -20 .. +55 °C (-4 .. 131 °F) | |
| Storage temperature: | -30 .. +70 °C (-22 .. 158 °F) | |
| Dielectric strength: | | |
| supply - output 1 (1, 3, 4) | 2.5 kV AC | |
| supply - output 2 (8, 9, 11) | 2.5 kV AC | |
| output 1 - output 2 | 2.5 kV AC | |
| Operating position: | any | |
| Mounting: | 11 pin octal socket | |
| Protection degree: | IP40 from front panel | |
| Overvoltage category: | | |
| for supply voltage | 12-150V AC/DC III. | |
| for supply voltage | 150-240V AC/DC II. | |
| Pollution degree: | 2 | |
| Dimensions: | 48x48x79mm (1.7"x1.7"x3.1") | 48x48x89mm (1.7"x1.7"x3.5") |
| Weight: | 111 g (3.9 oz.) | 108 g (3.81 oz.) |
| Standards: | EN 61812-1 | |

* for adjustable delay <100 ms, a time deviation of ± 10 ms applies

- Multifunction time relay for universal use in automation, control and regulation or in house installations.
- Potential-free control input (Control Switch Trigger).
- Possibility to select the control element for fine time setting:
- PTRM-216K - knob, for easy handling without the need for tools.
- PTRM-216T - rotary switch, for the possibility of using a sealable cover.
- All functions initiated by the supply voltage, except for the flasher function, can use the control input to inhibit the delay (pause).
- Mode selection - according to the set function, permanently closed, permanently open, and switching of the second output contact according to the supply voltage.
- Multifunction red LED flashes or shines depending on the operating status.

Description

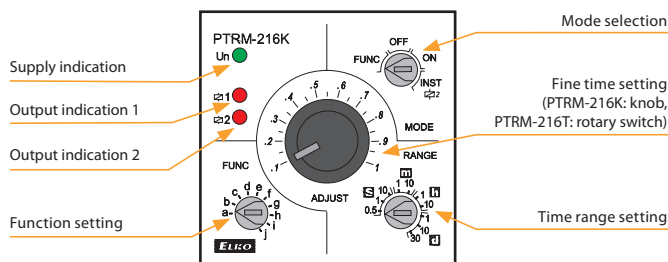

Connection

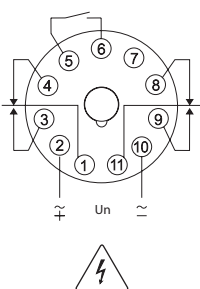

Do not apply voltage to terminals 5, 6, 7!

Indication of operating states

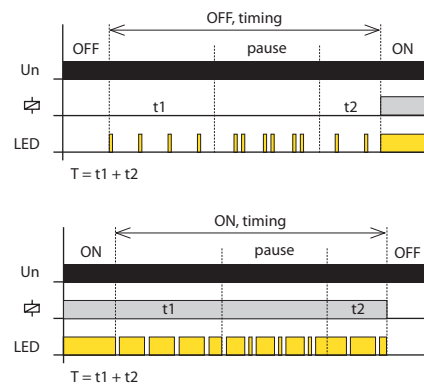

Mode selection

FUNC. Settings function mode
The desired function a-j is set with the FUNC rotary switch.

OFF. Output contact open mode



ON. Output contact closed mode



INST. Second output contact instantaneous



The second output contact switches according to the supply voltage. The first output contact switches according to the function (a-j) set by the trimmer FUNC.

Function

Functions (page 28).

Function

a. ON DELAY



When the supply voltage is applied, the time delay T begins. When the timing is complete, the relay closes and this condition continues until the supply voltage is disconnected.

ON DELAY with Inhibit

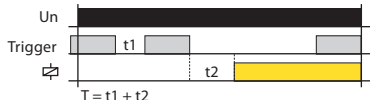

If the control contact is closed and the supply voltage is connected, the relay is opened and timing does not start until the control contact opens. When the timing is complete, the relay closes. If the control contact is closed during timing, the timing is interrupted and continues only after the control contact opens.

b. INTERVAL ON



After supply voltage relay closes and starts the delay time T. After the end of the timing relay opens and this state lasts until the supply voltage is disconnected.

INTERVAL ON with Inhibit

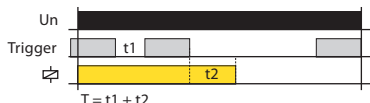

If the control contact is closed and the supply voltage is connected, the relay will close and the timing will start only after the control contact has been opened. When the timing is complete, the relay opens. If the control contact is closed during timing, the timing is interrupted and continues only after the control contact opens.

c. FLASHER - ON first



After supply voltage relay closes and starts the delay time T. After the end of the timing relay opens and again runs delay time T. When the timing is complete, the relay closes again and the sequence is repeated until the supply voltage is disconnected. If the control contact is closed during timing, this does not affect the operation of the cyclor.

FLASHER - OFF first



If the control contact is closed during timing; this does not affect the operation of the cyclor. If the control contact is closed and the supply voltage is connected, the cyclor starts with a pause (relay open).

d. MEMORY LATCH



When the supply voltage is applied, the relay is open. When the control contact is closed, the relay closes. The status does not change when the control contact is opened. When the control contact is closed again, the relay opens. Each time the control contact is closed, the relay changes status.

e. OFF DELAY



When the supply voltage is applied, the relay is open. When the control contact is closed, the relay closes. When the control contact opens, the time delay T begins. If the control contact is closed during timing, the time is reset and the relay remains closed. When the control contact opens, the time delay T starts again and opens when the relay closes.

f. SINGLE SHOT



When the supply voltage is applied, the relay is open. When the control contact is closed, the relay closes and the time delay T begins. Closing the control contact during timing is ignored.

g. WATCHDOG



When the supply voltage is applied, the relay is open. When the control contact is closed, the relay closes and the time delay T begins. Closing the control contact during timing triggers a new time delay T - the relay closing time is thus increased.

h. PULSE GENERATOR 0.5 s

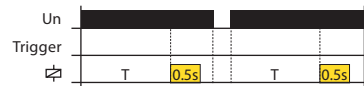

After the supply voltage has been applied, the time delay T begins. When the timing is complete, the relay closes for a fixed time (0.5 s).

PULSE GENERATOR 0.5 s with Inhibit

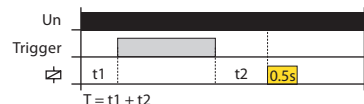

After supply voltage starts the time delay T. By closing timing of the control contact during timing is suspended. When the control contact opens, the time interval is completed and the relay closes for a fixed time (0.5 s).

i. INTERVAL ON/OFF

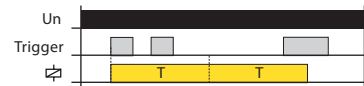

When the supply voltage is applied, the relay is open. When the control contact is closed, the relay closes and the time delay T begins. When the control contact is opened, the relay closes and the time delay T begins. If the control contact is open during timing, the relay remains closed for 2T. When the timing is complete, the relay opens. Any other change of control contact status during timing is ignored.

j. ON/OFF DELAY



When the supply voltage is applied, the relay is open. If control contact is closed, time delay T starts. When the control contact is opened, a new time delay T begins. If the control contact is open during timing, the relay closes at the end of the timing and opens the relay after the new time delay. Any other change of control contact status during timing is ignored.



EAN code
PTRA-216T/UNI: 8595188175609
PTRA-216K/UNI: 8595188175593

| Technical parameters | PTRA-216T | PTRA-216K |
|----------------------|-----------|-----------|
|----------------------|-----------|-----------|

| Power supply | | |
|---------------------------|---|--|
| Power pins: | 2, 10 | |
| Voltage range: | AC/DC 12 – 240 V (AC 50-60 Hz) | |
| Power input (max.): | 2.5 VA/1.5 W | |
| Supply voltage tolerance: | ±10 % | |
| Supply indication: | green LED | |
| Time circuit | | |
| Number of functions: | 10 | |
| Time ranges: | 50 ms - 30 days | |
| Time setting: | rotary switch and potentiometer | |
| Time deviation*: | 5 % - mechanical setting | |
| Repeat accuracy: | 0.2 % - set value stability | |
| Temperature coefficient: | 0.01 %/°C, at = 20 °C (0.01 %/°F, at = 68 °F) | |

| Output | | |
|-------------------------|--|--|
| Number of contacts: | 2x changeover/SPDT (AgNi) | |
| Current rating: | 16 A/AC1; 1 HP 240 Vac, 1/2 HP 120 Vac; PD. B300 | |
| Breaking capacity: | 4000 VA/AC1, 384 W/DC | |
| Switching voltage: | 250 V AC/24 V DC | |
| Max. power dissipation: | 2.4 W | |
| Output indication: | multifunction red LED | |
| Mechanical life: | 10.000.000 ops. | |
| Electrical life (AC1): | 100.000 ops. | |

| Control | | |
|-----------------|---------------------------|--|
| Control pins: | 5 - 2, 6 - 2, 7 - 2 | |
| Impulse length: | min. 25 ms/max. unlimited | |
| Reset time: | max. 150 ms | |

| Other information | | |
|------------------------|--------------------------------------|-----------------------------|
| Operating temperature: | -20 .. +55 °C (-4 .. 131 °F) | |
| Storage temperature: | -30 .. +70 °C (-22 .. 158 °F) | |
| Dielectric strength: | supply - output 1 (1, 3, 4) | 2.5 kV AC |
| | supply - output 2 (8, 9, 11) | 2.5 kV AC |
| | output 1 - output 2 | 2.5 kV AC |
| Operating position: | any | |
| Mounting: | 11 pin octal socket | |
| Protection degree: | IP40 from front panel | |
| Overvoltage category: | for supply voltage 12-150V AC/DC | III. |
| | for supply voltage 150-240V AC/DC | II. |
| | Pollution degree: | 2 |
| Dimensions: | 48x48x79mm (1.7"x1.7"x3.1") | 48x48x89mm (1.7"x1.7"x3.5") |
| Weight: | 111 g (3.9 oz.) | 108 g (3.81 oz.) |
| Standards: | EN 61812-1 | |

* for adjustable delay < 100 ms, a time deviation of ± 10 ms applies

- Multifunction time relay for universal use in automation, control and regulation or in house installations.
- Three control inputs - START, INHIBIT, RESET.
- Possibility to select the control element for fine time setting:
PTRA-216K - knob, for easy handling without the need for tools
PTRA-216T - rotary switch, for the possibility of using a sealable cover.
- Mode selection - according to the set function, permanently closed, permanently open, and switching of the second output contact according to the supply voltage.
- Multifunction red LED flashes or shines depending on the operating status.

Description

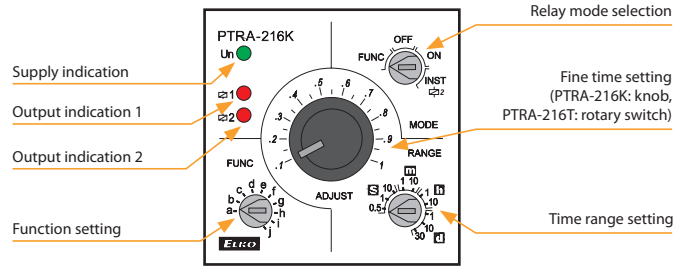

Connection Indication of operating states

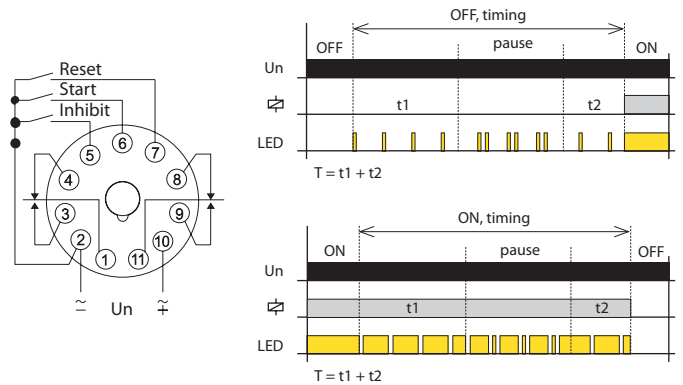

Mode selection

FUNC. Settings function mode
The desired function a-j is set with the FUNC rotary switch.

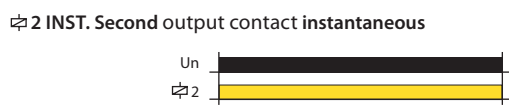
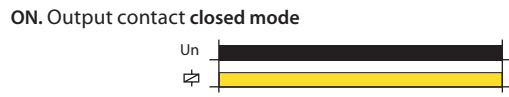
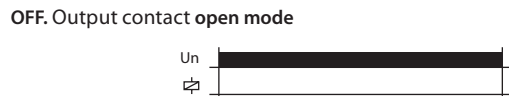

The second output contact switches according to the supply voltage. The first output contact switches according to the function (a-j) set by the trimmer FUNC.

Function

Functions (page 30).

Function

Control input function description:

- Contact START starts the time function
- INHIBIT contact pauses timing (pause)
- The RESET contact simulates switching the supply voltage on and off

Same for all features:

- If the control contact START is closed and the supply voltage is connected, the time function is activated when the supply voltage is connected.
- Closing the control contact INHIBIT pauses the timing, after opening the control contact INHIBIT timing continues from the moment of interruption.
- If the INHIBIT control contact is closed, the START control contact is activated and the timing is paused.
- Closing the control contact RESET immediately terminates the timing and the relay opens, just as when the supply voltage is disconnected.
- If the control contact RESET is closed and then the control contact START is closed, the time function is activated when the control contact RESET is opened as well as when the supply voltage is connected.

a. ON DELAY with Control Signal

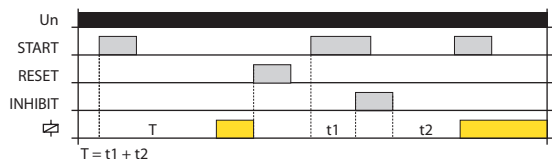

When the supply voltage is applied, the relay is open. If the control contact START is closed, the time delay T starts. The closing of the START control contact during timing is ignored.

b. INTERVAL ON with Control Signal

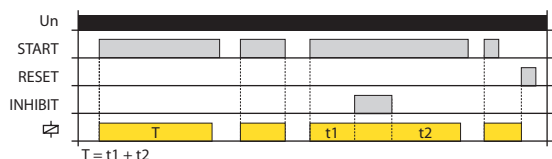

When the supply voltage is applied, the relay is open. When the control contact START is closed, the relay closes and the time delay T begins. If the START control contact is open during timing, the time interval is immediately terminated and the relay opens.

c. FLASHER - ON first with Control Signal

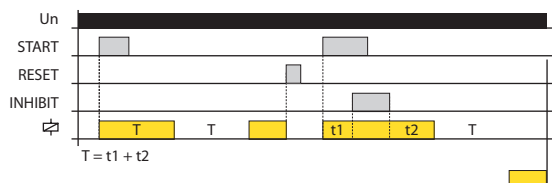

When the supply voltage is applied, the relay is open. When the START control contact is closed, the relay energizes and starts the delay time T . After the end of the timing relay opens and again runs delay time T . Upon completion timing again switches, and the sequence is repeated until the supply voltage is disconnected.

d. FLASHER - OFF first with Control Signal

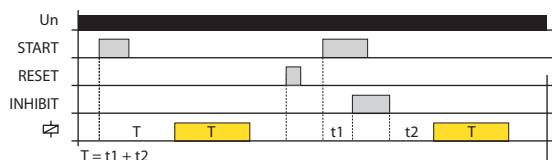

When the supply voltage is applied, the relay is open. When the START control contact is closed, starts the time delay T . After the end of the timing relay closes and again runs delay time T . After the end of the timing relay opens and the sequence is repeated until the supply voltage is disconnected.

e. OFF DELAY

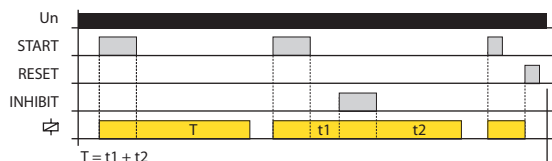

When the supply voltage is applied, the relay is open. If the control contact START is closed, the relay closes. After tripping Contact Start starts the delay time T . After the end of the timing relay is switched off.

f. SINGLE SHOT

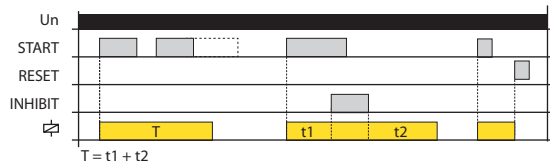

When the supply voltage is applied, the relay is open. When the START control contact is closed, the relay energizes and starts the delay time T . After the end of the timing relay is switched off. The closing of the START control contact during timing is ignored.

g. WATCHDOG

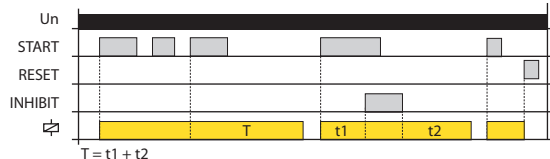

When the supply voltage is applied, the relay is open. When the START control contact is closed, the relay energizes and starts the delay time T . After the end of the timing relay is switched off. Closing control contact START during timing triggers a new time delay T - the relay closing time is thus increased.

h. PULSE GENERATOR 0.5 s with Control Signal

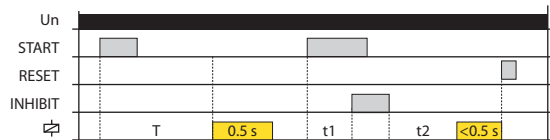

When the supply voltage is applied, the relay is open. When the START control contact is closed, starts the time delay T . After the end of the timing relay switches for the fixed time (0.5 sec).

i. INTERVAL ON/OFF

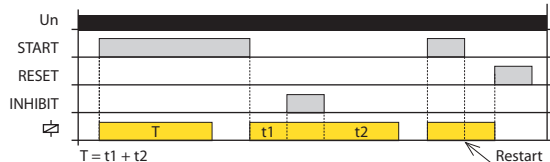

When the supply voltage is applied, the relay is open. When the START control contact is closed, the relay energizes and starts the delay time T . After the end of the timing relay is switched off. By opening the control contact start relay again closes and starts the delay time T . After the end of the timing relay is switched off.

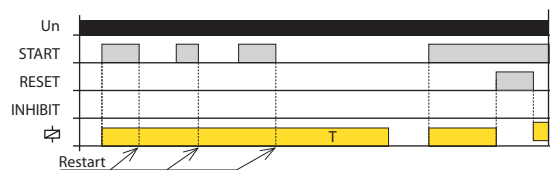

If the START control contact is open during timing, a restart occurs - the relay remains closed and a new time delay T begins. When the timing is complete, the relay opens.

j. ON/OFF DELAY

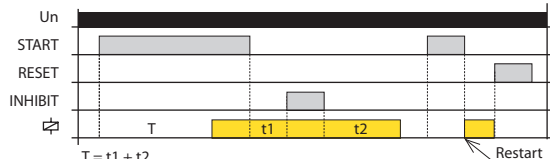

When the supply voltage is applied, the relay is open. When the START control contact is closed, starts the time delay T . After the end of the timing relay switches. Opening the control contact START starts a new time delay T . When the timing is complete, the relay opens.

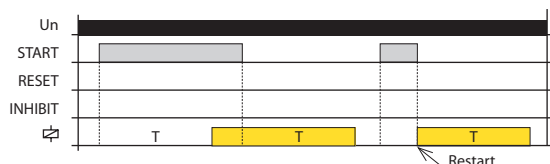

If the START control contact is open during timing, a restart occurs - the relay closes and a new time delay T begins. When the timing is complete, the relay opens.

1-phase

AC/DC



HRN-31, HRN-31/2

Multifunction, supply and monitored voltage in range of AC/DC 48-276 V, 1x (HRN-31) / 2x (HRN-31/2) output for Umax and Umin with adjustable levels.
page 33



HRN-32/2

As HRN-31/2 but individual output for each level (Umax/Umin).
page 33



HRN-39, HRN-39/2

Multifunction, supply and monitored voltage in range of AC/DC 24-150 V, 1x (HRN-39) / 2x (HRN-39/2) output for Umax and Umin with adjustable levels.
page 33



PMR1-31, PMR1-31/2

Same as HRN-31 and HRN-31/2, but in PLUG-IN design.
page 35



PMR1-39, PMR1-39/2

Same as HRN-39 and HRN-39/2, but in PLUG-IN design.
page 35

DC



HRN-36, HRN-36/2

Multifunction, supply and monitored voltage in range of DC 6-30 V, 1x (HRN-36) / 2x (HRN-36/2) output for Umax and Umin with adjustable levels.
page 33



PMR1-36, PMR1-36/2

Same as HRN-36 and HRN-36/2, but in PLUG-IN design.
page 35



HRN-56/208

Adjustable level Umin.
page 37



HRN-56/240

Adjustable level Umin.
page 37



HRN-56/400

Adjustable level Umin.
page 37



HRN-56/480

Adjustable level Umin.
page 37



HRN-56/575

Adjustable level Umin.
page 37



HRN3-81

Fixed range (208-480 V), asymmetry (2-10 % +OFF), 1x output contact, TRUE RMS.
page 40



HRN3-70

Adjustable range (190-500 V), asymmetry (2-10 % +OFF), undervoltage (80-95 % from the range), restart delay (1-300 s), selectable memory, 2x output contact, TRUE RMS.
page 38



PMR3-70

Same as HRN3-70, but in PLUG-IN design and with 1x output contact.
page 38



HRN3-80

Adjustable range (208-480 V), asymmetry (2-10 % +OFF), undervoltage (80-95 % from the range), 1x output contact, TRUE RMS.
page 40

| Type | Design | Supply from | Galvanically isolated | Features | | | Phase | | | Setting | | | | Description | Page | | |
|--|--------|-------------------|-----------------------|----------|--|----|-------|--------------|---------|----------|--------------|-------|---------------|-------------|------|---|--------|
| | | | | Phases | Monitored range | >U | <U | ≥U | Failure | Sequence | Asymmetry | Delay | Restart delay | | | Hysteresis | Memory |
| HRN-31 HRN-31/2 | 1-M | monitored voltage | x | 1 | AC/DC 48 - 276 V | ● | ● | ● | x | x | x | ● | x | ● | ● | All types have 9 functions in total. The delay is adjustable from 0 - 10 seconds (to eliminate short-term outages or peaks). The lower voltage level (Umin) is set in % of the upper level (Umax). | 33 |
| HRN-32/2 | 1-M | monitored voltage | x | 1 | AC/DC 48 - 276 V | ● | ● | ● | x | x | x | ● | x | ● | ● | | |
| HRN-36 HRN-36/2 | 1-M | monitored voltage | x | 1 | DC 6 - 30 V | ● | ● | ● | x | x | x | ● | x | ● | ● | | |
| HRN-39 HRN-39/2 | 1-M | monitored voltage | x | 1 | AC/DC 24 - 150 V | ● | ● | ● | x | x | x | ● | x | ● | ● | Old types replacement: HRN-33 > HRN-31 HRN-34 > HRN-36 HRN-35 > HRN-32/2 HRN-37 > HRN-39 | 47 |
| PMR1-31 PMR1-31/2 | 8-PIN | monitored voltage | x | 1 | AC/DC 48 - 276 V | ● | ● | ● | x | x | x | ● | x | ● | ● | | |
| PMR1-36 PMR1-36/2 | 8-PIN | monitored voltage | x | 1 | DC 6 - 30 V | ● | ● | ● | x | x | x | ● | x | ● | ● | | |
| PMR1-39 PMR1-39/2 | 8-PIN | monitored voltage | x | 1 | AC/DC 24 - 150 V | ● | ● | ● | x | x | x | ● | x | ● | ● | HRN-32/2: separated output contact for overvoltage and undervoltage | |
| HRN-56/208 HRN-56/240 HRN-56/400 | 1-M | monitored voltage | x | 3 | AC 3 x 125 - 276 V AC 3 x 144 - 276 V AC 3 x 240 - 460 V | x | ● | x | ● | ● | x | ● | x | x | x | Thanks to the power supply from all three phases, the relay is operational even if one phase fails. | 37 |
| HRN-56/480 HRN-56/575 | 3-M | monitored voltage | x | 3 | AC 3 x 228 - 550 V AC 3 x 345 - 660 V | x | ● | x | ● | ● | x | ● | x | x | x | | |
| HRN3-70 | 3-M | monitored voltage | x | 3 | AC 3 x 190 - 500 V | x | x | ● (fixed) | ● | ● | ● (+ OFF) | ● | ● | x | ● | Selectable nominal voltage from 190 to 500 V. Adjustable restart delay from 1 to 300 s. Two output contacts, changeover 16 A. * (o-fixed) = over voltage value is fixed (110% from selected range). | 38 |
| PMR3-70 | 3-M | monitored voltage | x | 3 | AC 3 x 190 - 500 V | x | x | ● (fixed) | ● | ● | ● (+ OFF) | ● | ● | x | ● | | |
| HRN3-80 | 1-M | monitored voltage | x | 3 | AC 3 x 208 - 480 V | x | ● | x | ● | ● | ● (+ OFF) | ● | x | x | x | Selectable nominal voltage from 208 to 480 V. | 40 |
| HRN3-81 | 1-M | monitored voltage | x | 3 | AC 3 x 208 - 480 V | x | x | x | ● | ● | ● (+ OFF) | ● | x | x | x | Works in range from 208 to 480 V. | 40 |



EAN code
 HRN-31: 8595188184946
 HRN-31/2: 8595188184380
 HRN-32/2: 8595188185394
 HRN-36: 8595188184953
 HRN-36/2: 8595188182553
 HRN-39: 8595188184960
 HRN-39/2: 8595188184939

- It is used to monitor the value of alternating or direct voltage in 1-phase circuits.
- Supply voltage from monitored voltage.
- Monitors voltage exceeding the upper voltage level (Umax) and falling below the lower voltage level (Umin) – according to the selected function.
- Smooth adjustment of both voltage levels – the lower level Umin is set in % of the upper level Umax.
- Adjustable time delay (to eliminate short-term voltage drops and spikes).
- Option to select functions with fault state memory (Latch).
- The fault state memory can be reseted by the control input (R).
- Measures true root mean square value of the voltage - TRUE RMS.
- Type HRN-32/2 has an independent output contact for each voltage level.

| Technical parameters | HRN-31 HRN-31/2 | - HRN-32/2 | HRN-36 HRN-36/2 | HRN-39 HRN-39/2 |
|----------------------|--------------------|---------------|--------------------|--------------------|
|----------------------|--------------------|---------------|--------------------|--------------------|

| Supply and measuring | A1-A2 | | | |
|-----------------------------|------------------------------------|------------------------------------|-----------------|------------------------------------|
| Supply/monitored terminals: | A1-A2 | | | |
| Supply/monitored voltage: | AC/DC 48–276 V (AC 50-60 Hz) | AC/DC 48–276 V (AC 50-60 Hz) | DC 6–30 V | AC/DC 24–150 V (AC 50-60 Hz) |
| Consumption (max.): | 2.5 VA/0.55 W 2.7 VA/0.65 W | - 2.7 VA/0.65 W | 0.35 W 0.5 W | 2.5 VA/0.55 W 2.7 VA/0.65 W |
| Upper level setting (Umax): | AC/DC 160–276 V | AC/DC 160–276 V | DC 12–30 V | AC/DC 80–150 V |
| Lower level setting (Umin): | 30–95%Umax | 30–95%Umax | 50–95%Umax | 30–95%Umax |
| Max. permanent voltage: | AC/DC 276 V | AC/DC 276 V | DC 36 V | AC/DC 276 V |
| Peak overload (1 s): | AC/DC 290 V | AC/DC 290 V | DC 48 V | AC/DC 290 V |
| Time delay (d): | 300 ms | | | |
| Time delay (t): | adjustable, 0.5 – 10 s | | | |

| Accuracy | |
|---------------------------|---|
| Setting accuracy (mech.): | 5 % – mechanical setting |
| Repeat accuracy: | < 1 % |
| Temperature dependency: | < 0.1 %/°C (°F) |
| Hysteresis (fault to OK): | 5 % (functions O1, U1, W) Umax – Umin (functions O2, U2, U3) |

| Output | | | | |
|---------------------------|--|---------------------------------|--------------------------------|--------------------------------|
| Contact type: | 1x changeover 2x changeover | 1x changeover for each level | 1x changeover 2x changeover | 1x changeover 2x changeover |
| Contact material: | AgNi | | | |
| Current rating: | 16 A/AC1; 1 HP 240 Vac, 1/2 HP 120 Vac; PD. B300 | | | |
| Breaking capacity: | 4000 VA/AC1, 384 W/DC1 | | | |
| Switching voltage: | 250 V AC/24 V DC | | | |
| Power dissipation (max.): | HRN-3x (1.2 W) HRN-3x/2 (2.4 W) | | | |
| Mechanical life: | 10.000.000 ops. | | | |
| Electrical life (AC1): | 100.000 ops. | | | |

| Other information | |
|---|---|
| Operating temperature: | -20 .. +55 °C (-4 .. 131 °F) |
| Storage temperature: | -30 .. +70 °C (-22 .. 158 °F) |
| Dielectric strength: | AC 4 kV (supply – output) |
| Operating position: | any |
| Mounting: | DIN rail EN 60715 |
| Protection degree: | IP40 front panel / IP20 terminals |
| Overvoltage category: | III. |
| Pollution degree: | 2 |
| Cross-wire section – solid/ stranded with ferrule (mm²): | max. 1x 2.5, 2x 1.5/ max. 1x 2.5 (AWG 14) |
| Dimensions: | 90 x 17.6 x 64 mm (3.5" x 0.7" x 2.5") |
| Weight: | 60 g (2.11 oz) - 60 g (2.11 oz) 60 g (2.11 oz) 77 g (2.72 oz) 77 g (2.72 oz) 77 g (2.72 oz) 77 g (2.72 oz) |
| Standards: | EN 60255-1, EN 60255-26, EN 60255-27 |

Description

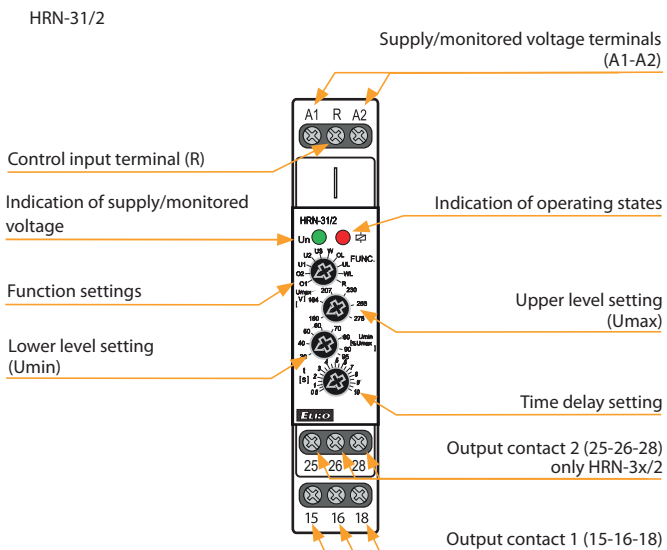

Connection

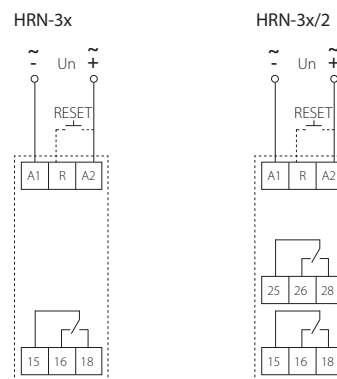

Indication of operating states

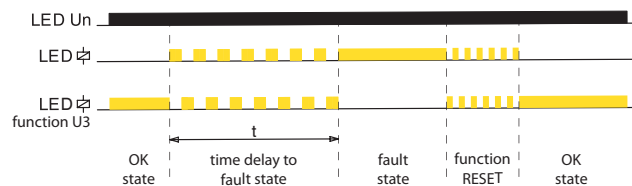

Function

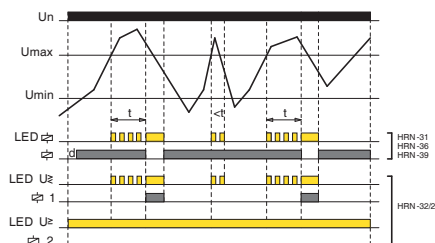
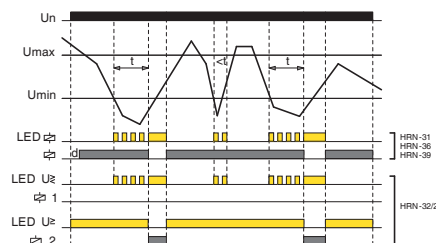
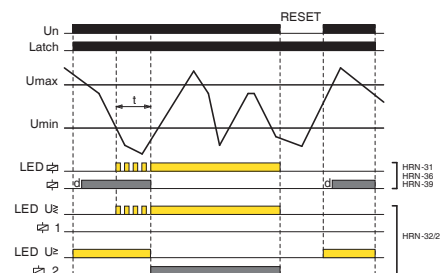
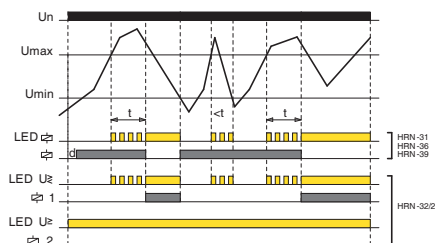
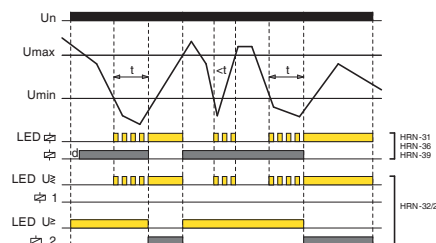
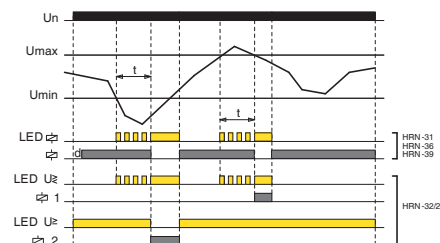
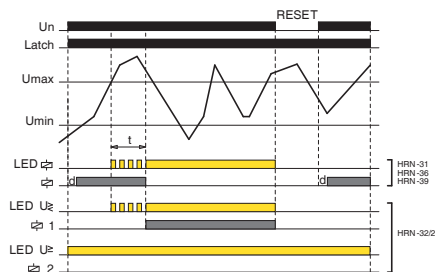
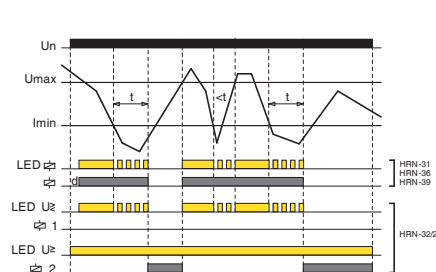
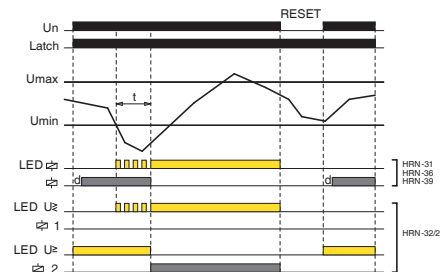
O1 OVER (hysteresis 5%)**U1** UNDER (hysteresis 5%)**UL** UNDER + Latch**O2** OVER (hysteresis to U_{min})**U2** UNDER (hysteresis to U_{max})**W** WINDOW (hysteresis 5%)**OL** OVER + Latch**U3** UNDER (hysteresis to U_{max})**WL** WINDOW + Latch**OVER:**

If the value of the monitored voltage is lower than the set upper level „ U_{max} “, the output contact is closed. If the „ U_{max} “ is exceeded, the output contact will open after the set delay (fault state).

If the voltage falls below the fixed hysteresis (O1 function) or the set lower level „ U_{min} “ (O2 function), the output contact will close again.

If the OL function (OVER + Latch) is selected, when the upper voltage level „ U_{max} “ is exceeded, the output contact remains open even when the voltage returns from the fault state.

Fault memory reset can be done in three ways:

- Short-term interruption of supply voltage
- Using the control input (R)
- By setting the function switch to position R (RESET) or any function without memory fault

The RESET state lasts for 3 s after switching the function switch from the R position to a function with a memory fault (UL, OL, WL).

When moving to any other function from the R position, this delay does not apply.

UNDER:

If the value of the monitored voltage is higher than the set lower level „ U_{min} “, the output contact is closed. When the voltage drops below the „ U_{min} “, output contact opens after the set delay (fault state).

If the voltage exceeds the fixed hysteresis (function U1) or the set upper level „ U_{max} “ (function U2, U3), the output contact closes again.

If the UL function (UNDER + Latch) is selected, when the voltage drops below the lower level „ U_{min} “, the output contact remains open even when returning from the fault state. Fault memory reset can be done as in the previous case.

WINDOW:

If the value of the monitored voltage is lower than upper level „ U_{max} “ and at the same time higher than lower level „ U_{min} “, the output contact is closed. If the „ U_{max} “ is exceeded or drops below the „ U_{min} “, output contact opens after the set delay (fault state).

To return from the fault state, a fixed hysteresis is applied.

If the WL function (WINDOW + Latch) is selected, the fault state is again stored in memory and output contact stays open, even when returning from the fault state. Fault memory reset can be done as in the previous cases.



PMR1-31: (8595188188654)
 PMR1-31/2: (8595188185363)
 PMR1-36: (8595188188661)
 PMR1-36/2: (8595188188678)
 PMR1-39: (8595188188685)
 PMR1-39/2: (8595188188692)

- It is used to monitor the value of alternating or direct voltage in 1-phase circuits.
- Supply voltage from monitored voltage.
- Monitors voltage exceeding the upper voltage level (Umax) and falling below the lower voltage level (Umin) – according to the selected function.
- Smooth adjustment of both voltage levels – the lower level Umin is set in % of the upper level Umax.
- Adjustable time delay (to eliminate short-term voltage drops and peaks).
- Option to select functions with fault state memory (Latch).
- The fault state memory can be reseted with a button on the panel (RESET).
- Measures true root mean square value of the voltage - TRUE RMS.

| Technical parameters | PMR1-31 PMR1-31/2 | PMR1-36 PMR1-36/2 | PMR1-39 PMR1-39/2 |
|-----------------------------|--|------------------------------------|----------------------------------|
| Supply and measuring | AC/DC 48 – 276 V | DC 6 – 30 V | AC/DC 24 – 150 V |
| Supply/monitored terminals: | (AC 50-60 Hz) | 2-7 | (AC 50-60 Hz) |
| Supply/monitored voltage: | 2.5 VA/0.55 W 2.7 VA/0.65 W | 0.35 W 0.5 W | 2.5 VA/0.55 W 2.7 VA/0.65 W |
| Consumption (max.): | AC 160 – 276 V 30 – 95 %Umax | DC 12 – 30 V 50 – 95 %Umax | AC 80 – 150 V 30 – 95 %Umax |
| Upper level setting (Umax): | AC 276 V | DC 36 V | AC 276 V |
| Lower level setting (Umin): | AC 290 V | DC 48 V | AC 290 V |
| Max. permanent voltage: | | | |
| Peak overload (1 s): | | | |
| Time delay (d): | | 300 ms | |
| Time delay (t): | | adjustable, 0.5 – 10 s | |
| Accuracy | | | |
| Setting accuracy (mech.): | | 5 % – mechanical setting | |
| Repeat accuracy: | | < 1 % | |
| Temperature dependency: | | < 0.1 %/°C (°F) | |
| Hysteresis (fault to OK): | | 5 % (functions O1, U1, W) | |
| | | Umax – Umin (functions O2, U2, U3) | |
| Output | | | |
| Contact type: | 1× changeover 2× changeover | 1× changeover 2× changeover | 1× changeover 2× changeover |
| Contact material: | AgNi | | |
| Current rating: | 13 A/AC1; 1 HP 240 Vac, 1/2 HP 120 Vac; PD. B300 | | |
| Breaking capacity: | 4000 VA/AC1, 384 W/DC1 | | |
| Switching voltage: | 250 V AC/24 V DC | | |
| Power dissipation (max.): | PMR1-3x (1.2 W) PMR1-3x/2 (2.4 W) | | |
| Mechanical life: | 10.000.000 ops. | | |
| Electrical life (AC1): | 100.000 ops. | | |
| Other information | | | |
| Operating temperature: | –20 .. 55 °C (–4 .. 131 °F) | | |
| Storage temperature: | –30 .. 70 °C (–22 .. 158 °F) | | |
| Dielectric strength: | AC 4 kV (supply – output) | | |
| Operating position: | any | | |
| Mounting: | DIN rail EN 60715 | | |
| Protection degree: | IP40 front panel / IP20 terminals | | |
| Overvoltage category: | III. | | |
| Pollution degree: | 2 | | |
| Dimensions: | 48 × 48 × 79 mm (1.89" × 1.89" × 3.11") | | |
| Weight: | 94 g (3.32 oz) 105 g (3.7 oz) | 94 g (3.32 oz) 105 g (3.7 oz) | 94 g (3.32 oz) 105 g (3.7 oz) |
| Standards: | EN 60255-1, EN 60255-26, EN 60255-27 | | |

Description

PMR1-31

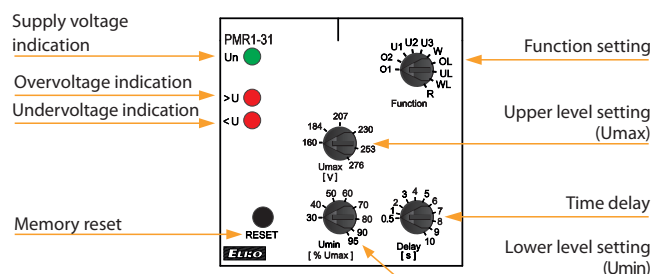

Connection

PMR1-3x

PMR1-3x/2

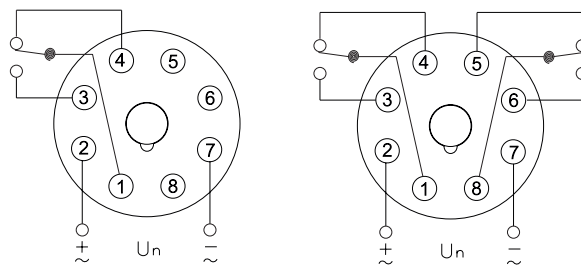

Indication of operating states

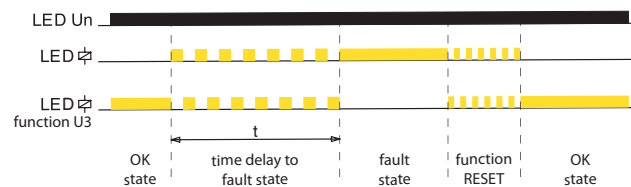

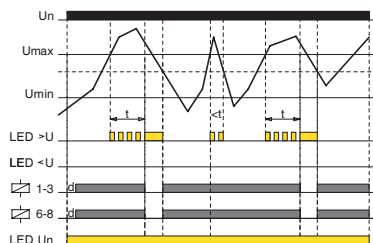
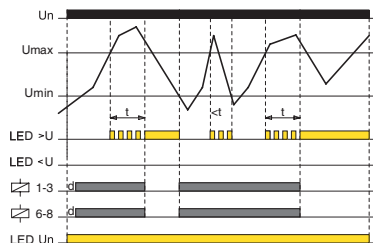
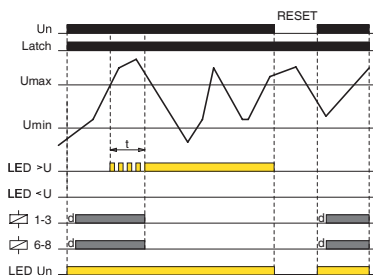
O1 OVER (hysteresis 5%)**O2 OVER (hysteresis to Umin)****OL OVER + Latch****OVER:**

If the value of the monitored voltage is lower than the set upper level „ U_{max} “, the output contact is closed. If the „ U_{max} “ is exceeded, the output contact will opens after the set delay (fault state).

If the voltage falls below the fixed hysteresis (O1 function) or the set lower level „ U_{min} “ (O2 function), the output contact will closes again.

If the OL function (OVER + Latch) is selected, when the upper voltage level „ U_{max} “ is exceeded, the output contact remains open even when the voltage returns from the fault state.

Fault memory reset can be done in three ways:

- Using memory reset button on the panel
- Short-term interruption of supply voltage
- By setting the function switch to position R (RESET) or any function without memory fault

The RESET state lasts for 3 s after switching the function switch from the R position to a function with a memory fault (UL, OL, WL).

When moving to any other function from the R position, this delay does not apply.

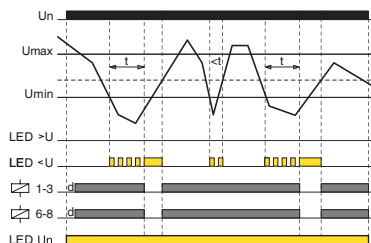
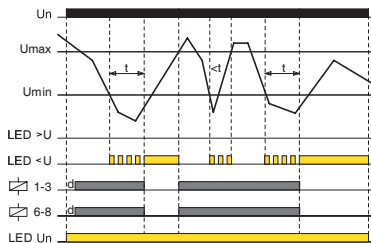
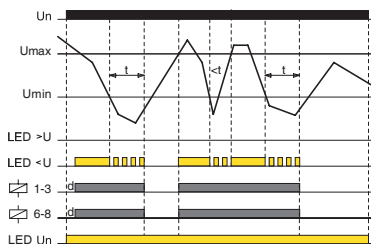
U1 UNDER (hysteresis 5%)**U2 UNDER (hysteresis to Umax)****U3 UNDER (hysteresis to Umax)****UNDER:**

If the value of the monitored voltage is higher than the set lower level „ U_{min} “, the output contact is closed. When the voltage drops below the „ U_{min} “, output contact opens after the set delay (fault state).

If the voltage exceeds the fixed hysteresis (function U1) or the set upper level „ U_{max} “ (function U2, U3), the output contact closes again.

If the UL function (UNDER + Latch) is selected, when the voltage drops below the lower level „ U_{min} “, the output contact remains open even when returning from the fault state. Fault memory reset can be done as in the previous case.

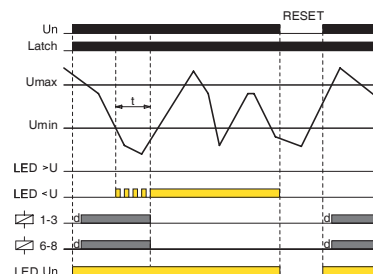
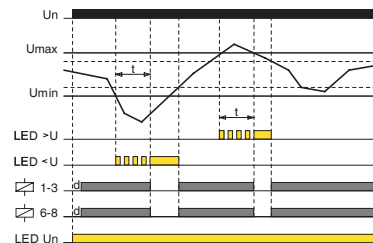
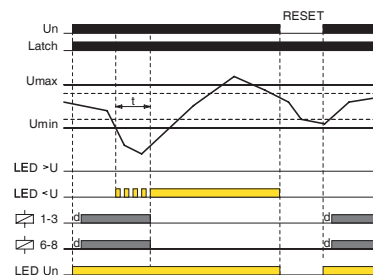
UL UNDER + Latch**W WINDOW (hysteresis 5%)****WL WINDOW + Latch****WINDOW:**

If the value of the monitored voltage is lower than upper level „ U_{max} “ and at the same time higher than lower level „ U_{min} “, the output contact in closed. If the „ U_{max} “ is exceeded or drops below the „ U_{min} “, output contact opens after the set delay (fault state).

To return from the fault state, a fixed hysteresis is applied.

If the WL function (WINDOW + Latch) is selected, the fault state is again stored in memory and output contact stays open, even when returning from the fault state. Fault memory reset can be done as in the previous cases.



EAN code
 HRN-56/208V: 8595188130134
 HRN-56/240V: 8595188137119
 HRN-56/400V: 8595188137126
 HRN-56/480V: 8595188130189
 HRN-56/575V: 8595188130196

| Technical parameters | HRN-56 | | | | |
|---|---|---|---|---|---|
| | 208 | 240 | 400 | 480 | 575 |
| Supply/monitoring terminals: | L1, L2, L3 | | | | |
| Supply/measured voltage: | 3x 208 V L-L (3x120 V L-N) (50-60 Hz) | 3x 240 V L-L (3x139 V L-N) (50-60 Hz) | 3x 400 V L-L (3x230 V L-N) (50-60 Hz) | 3x 480 V L-L (3x277 V L-N) (50-60 Hz) | 3x 575 V L-L (3x332 V L-N) (50-60 Hz) |
| Burden: | max. 2 VA/1 W | | | | |
| Max. dissipated power (Un + terminals): | 2 W | | | | |
| Level U _{min} : | adjustable 70 - 95 % Un | | | | |
| Level U _{off} : | 60 % Un | | | | |
| Hysteresis: | 2 % | | | | |
| Max. permanent overload: | AC 3x 276 V | AC 3x 460 V | AC 3x 550 V | AC 3x 660 V | AC 3x 660 V |
| Peak overload <1s: | AC 3x 300 V | AC 3x 500 V | AC 3x 600 V | AC 3x 700 V | AC 3x 700 V |
| Time delay t1: | max. 500 ms | | | | |
| Time delay t2: | adjustable 0 - 10 s | | | | |
| Time delay t3: | max. 1 s | | | | |

| Output | | |
|------------------------|---|-----------------|
| Number of contacts: | 1x changeover/SPDT (AgNi/Silver Alloy) | |
| Current rating: | 8 A/AC1; 1/3 HP 240 Vac, 1/4 HP 120 Vac; PD. B300 | |
| Breaking capacity: | 2000 VA/AC1, 240 W/DC | |
| Inrush current: | 10 A | |
| Switching voltage: | 250 V AC/24 V DC | |
| Indication of state: | red LED | |
| Mechanical life: | 60.000.000 ops. | 30.000.000 ops. |
| Electrical life (AC1): | 150.000 ops. | 200.000 ops. |

| Other information | | |
|-------------------------------------|---|---|
| Operating temperature: | -20 .. +55 °C (-4 .. 131 °F) | |
| Storage temperature: | -30 .. +70 °C (-22 .. 158 °F) | |
| Dielectrical strength: | 4 kV (supply - output) | |
| Operating position: | any | |
| Mounting: | DIN rail EN 60715 | |
| Protection degree: | IP40 from front panel/ IP10 terminals | IP40 from front panel/ IP20 terminals |
| Overvoltage category: | III. | |
| Pollution degree: | 2 | |
| Max. cable size (mm ²): | solid wire max. 2x 2.5 or 1x 4/ with sleeve max. 1x 2.5 or 2x 1.5 (AWG 12) | max. 1x 2.5, max. 2x 1.5/ with sleeve max. 1x 1.5 (AWG 12) |
| Dimensions: | 90 x 17.6 x 64 mm (3.5" x 0.7" x 2.5") | 90 x 52 x 65 mm (3.5" x 2" x 2.6") |
| Weight: | 65 g (2.3 oz.) | 66 g (2.3 oz.) |
| Standards: | EN 60255-1, EN 60255-26, EN 60255-27 | |

- Relay monitors phase sequence and failure (e.g. control of correct motor winding etc.).
- Relay is designated for monitoring of 3-phase networks.
- Supply from all phases which means that relay is functional also in case of one phase failure.
- Supply and monitored supply Un:

| | |
|-----------------------|-----------------------|
| 1-MODULE | 3-MODULE |
| HRN-56/208 - 3x 208 V | HRN-56/480 - 3x 480 V |
| HRN-56/240 - 3x 240 V | HRN-56/575 - 3x 575 V |
| HRN-56/400 - 3x 400 V | |
- Fixed delay t1 (500 ms), adjustable delay t2 (0.1 - 10 s) and fixed delay t3 (max. 1 s).

Description

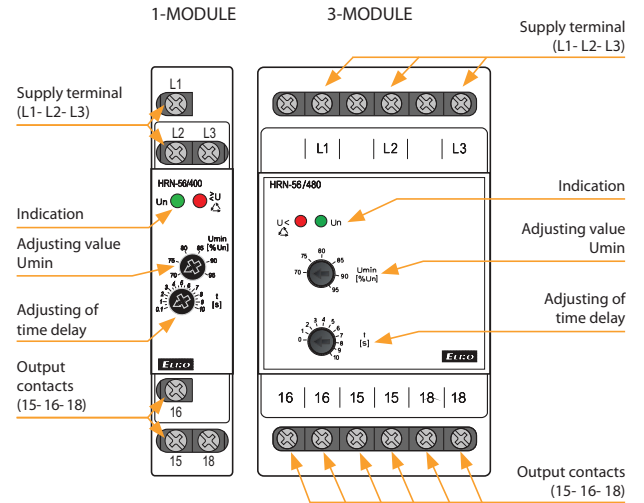

Function

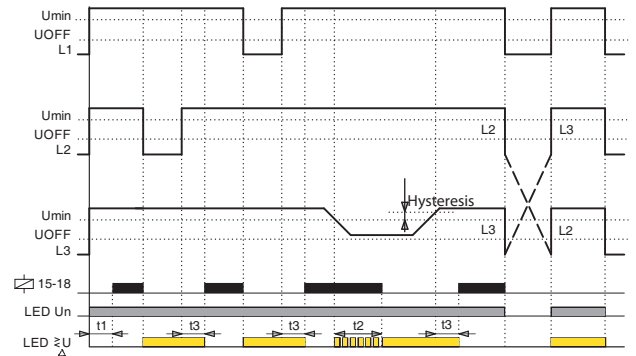

Connection

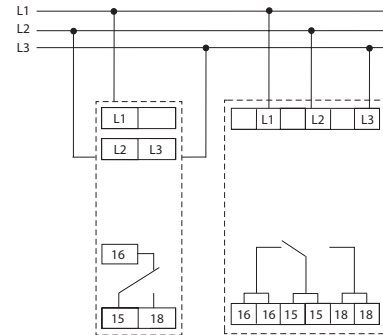

Symbol

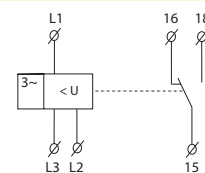

Function description

Relay in 3-phase main monitors correct phase sequence and phase failure. Green LED illuminates permanently and indicates energization. In case of phase failure red LED flashes and relay turns off. When changing to faulty state, time delay applies - delay setting is done by potentiometer on the front panel of the device. In case of incorrect phase sequence, red LED shines permanently and relay is open. In case supply voltage falls below 60 % Un (U_{off} - lower level), relay immediately opens with no delay and faulty state is indicate by red LED.

HRN-56: Thanks to supply from all phases, relay is functional also in case of one phase failure.



EAN code
HRN3-70: 8595188188838
PMR3-70: 8595188185288

| Technical parameters | HRN3-70 | PMR3-70 |
|---|--|--|
| Supply/monitored terminals: | L1-L2-L3 | 3-4-5 |
| Supply/monitored voltage: | AC 3× 190 – 500 V (50-60 Hz) | |
| Consumption (max.): | 2 VA/1 W | |
| Upper level (Umax): | 110 %Un | |
| Lower level (Umin): | 80 – 95 %Un | |
| Asymmetry: | adjustable, 2 – 10 %Un + OFF | |
| Max. permanent voltage: | AC 3× 550 V | |
| Peak overload (1 s): | AC 3× 600 V | |
| Time delay (t1): | 2 s | |
| Time delay (t2): | adjustable, 0.3 – 30 s | |
| Time delay (t3): | adjustable, 1 – 300 s | |
| Accuracy: | | |
| Hysteresis (fault to OK): | 5 % | |
| Output | | |
| Contact type: | 2× changeover (AgNi) | 1× changeover (AgNi) |
| Current rating: | 13 A/AC1; 1 HP 240 Vac, 1/2 HP 120 Vac; PD. B300 | |
| Breaking capacity: | 4000 A/AC1, 384 W/DC1 | |
| Switching voltage: | 250 V AC/24 V DC | |
| Power dissipation (max.): | 2.4 W | 1.2 W |
| Mechanical life: | 10.000.000 ops. | |
| Electrical life (AC1): | 100.000 ops. | |
| Other information | | |
| Operating temperature: | –20 .. 55 °C (–4 .. 131 °F) | |
| Storage temperature: | –30 .. 70 °C (–22 .. 158 °F) | |
| Dielectric strength: | | |
| supply – output 1 | AC 4 kV | AC 2.5 kV |
| supply – output 2 | AC 4 kV | - |
| output 1 – output 2 | AC 4 kV | - |
| Operating position: | any | |
| Mounting: | DIN rail EN 60715 | into socket (8-pin) |
| Protection degree: | IP40 front panel / IP20 terminals | IP40 |
| Overvoltage category: | III. | |
| Pollution degree: | 2 | |
| Cross-wire section – solid/ stranded with ferrule (mm²): | max. 1× 2.5, 2× 1.5/ max. 1× 2.5 (AWG 14) | max. 1× 4, 2× 2.5/ max. 1× 4 (AWG 12) |
| Dimensions: | 90 × 52 × 66 mm | 48 × 48 × 79 mm |
| Weight: | 140 g (4.94 oz) | 100 g (3.53 oz) |
| Standards: | EN 60255-1, EN 60255-26, EN 60255-27 | |

Range switch (Un)

The range switch has two ranges of phase-to-phase voltage values:

low (190 to 250V) and high (380 to 500V)

After connecting to the supply/monitored voltage, the device evaluates voltage size and selects the corresponding range of values. When switching between individual positions within the selected range, the green „LED Un“ will flash briefly.

- It is used for monitoring of voltage, phase failure, sequence and asymmetry in 3-phase network.
- Wide range of monitored voltage with automatic selection of a low/high range.
- Fixed overvoltage level (Umax), adjustable undervoltage level (Umin).
- Adjustable time delay t2 (to eliminate short-term voltage drops and peaks).
- Adjustable time delay t3 (to eliminate short-term OK state).
- Adjustable asymmetry level with option to turn it OFF.
- Measures true root mean square value of the voltage - TRUE RMS.
- Fault memory reset can be done by RESET button on the panel or by an external opening contact.

Description

HRN3-70

Supply/monitored terminals
(L1-L2-L3)

External reset terminals
of memory (R1-R2)

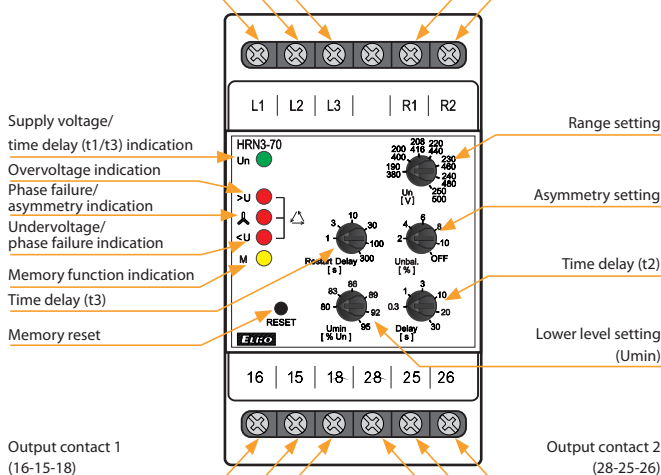

Connection

HRN3-70

PMR3-70

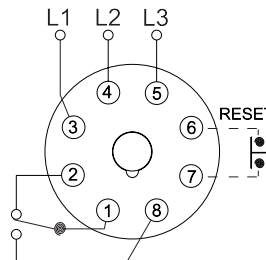
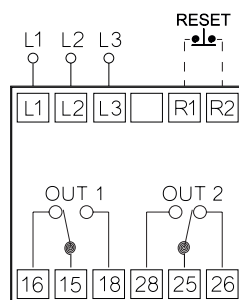

Overvoltage - undervoltage

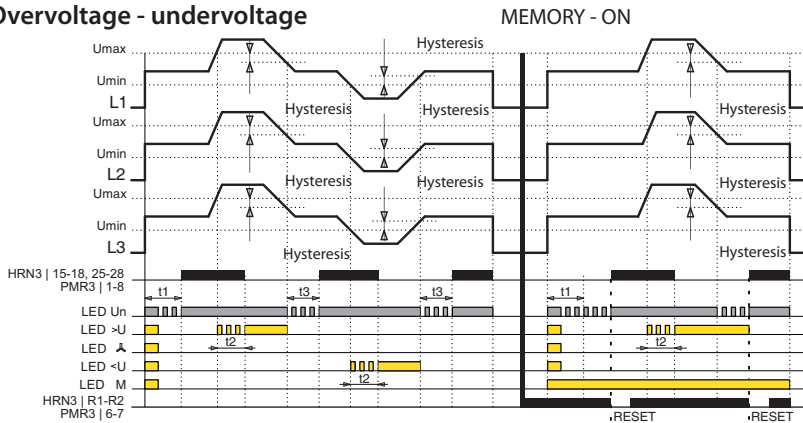

Graphs legend:

- L1, L2, L3 = 3-phase voltage
- RESET = memory reset
- t1 = time delay, after connecting to voltage
- t2 = time delay into fault state
- t3 = time delay to OK state
- 15-18 = output contact 1 (HRN3)
- 25-28 = output contact 2 (HRN3)
- 1-8 = output contact (PMR3)
- LED >U = overvoltage indication
- LED \triangleleft = undervoltage/phase failure indication
- LED Δ = phase failure/asymmetry indication
- LED M = memory function indication
- LED Un = supply/monitored voltage, time delay t1 and t3 indication

Phase asymmetry - failure

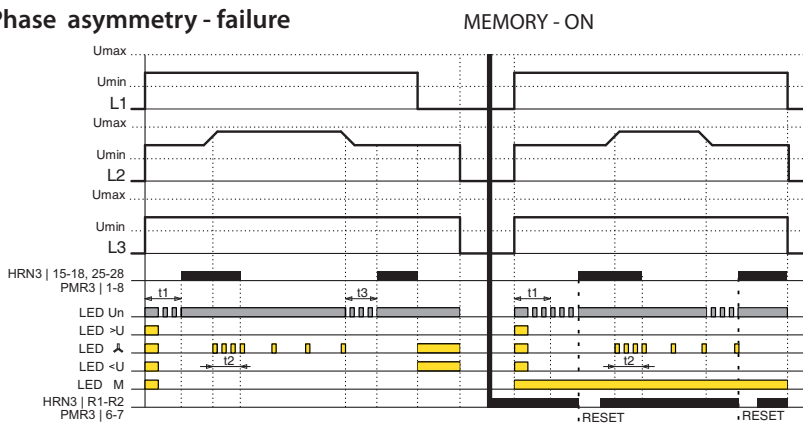

Phase sequence

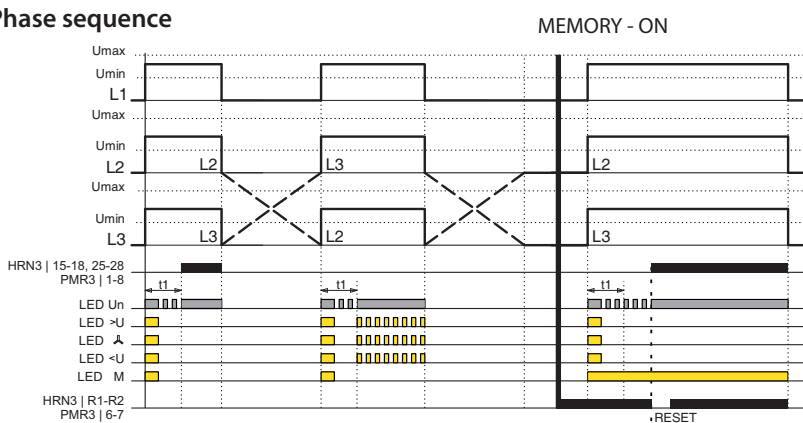

After connecting the device to the supply voltage, all the LEDs on the panel will flash briefly.

If a 3-phase voltage is connected to the monitoring relay and all conditions are met (correct voltage magnitude, sequence and phase asymmetry), the output contacts close after the time delay t1 has elapsed. During the time delay, the green „LED Un“ flashes, after the end of the delay it lights up permanently (OK state).

- When the voltage exceeds or falls outside the „Umin“ and „Umax“ levels, after the time delay t2 the green and the corresponding red „LED \triangleleft“ light up.

The output contacts are open (fault state). During the time delay, the red LED flashes.

- If the phase sequence is incorrect when the power is connected, after the time delay t1 the green „LED Un“ lights up + all 3 red „LEDs \triangleleft“ flash simultaneously.

The output contact is open (fault state). During the time delay, the green LED flashes.

- When the set phase asymmetry is exceeded, after the time delay t2 the green „LED Un“ lights up and the red „LED Δ“ flashes briefly.

The output contact is open (fault state). During the time delay, the red LED flashes rapidly.

- In the event of a phase failure, the output contacts open without a time delay t2 (fault state), the green „LED Un“ and the corresponding red „LED \triangleleft“ light up.

- To return from the fault state to the OK state, the time delay t3 is always applied. During this time delay, the green „LED Un“ flashes.

Reset and fault state memory activation:

By connecting terminals R1-R2 or pins 6-7 in the PLUG-IN version via an external push button with a break contact (RESET), the fault state memory is activated.

After turning on the power, the yellow „LED M“ on the device panel lights up. If a fault condition occurs, it is stored in memory. The red LED signalize fault just like in mode with fault state memory turned off. If the voltage values return to the set levels, the corresponding red LED will be permanently lit and at the same time the green „LED Un“ will start flashing. It is now possible to reset fault memory state, this closes the output contact and the red LED goes out (OK state). Fault memory reset (RESET) is performed either with an external pushbutton or with the pushbutton on device panel.



EAN code
HRN3-80: 8595188188814
HRN3-81: 8595188188821



| Technical parameters | HRN3-80 | HRN3-81 |
|----------------------|---------|---------|
|----------------------|---------|---------|

| Supply and measuring | | |
|-----------------------------|------------------------------|-------|
| Supply/monitored terminals: | L1-L2-L3 | |
| Supply/monitored voltage: | AC 3x 208 – 480 V (50-60 Hz) | |
| Consumption (max.): | 2 VA/1 W | |
| Range setting: | adjustable | fixed |
| Lower level setting (Umin): | 80 – 95 %Un | x |
| Asymmetry setting: | adjustable, 2 – 10 %Un + OFF | |
| Max. permanent voltage: | AC 3x 550 V | |
| Peak overload (1 s): | AC 3x 600 V | |
| Time delay (t1): | 2 s | |
| Time delay (t2): | adjustable, 0.3 – 30 s | |

| Accuracy | |
|---------------------------|-----------------|
| Setting accuracy (mech.): | 5 % |
| Repeat accuracy: | < 1 % |
| Temperature dependency: | < 0.1 %/°C (°F) |
| Hysteresis (fault to OK): | 5 % |

| Output | |
|---------------------------|--|
| Contact type: | 1x changeover/SPDT (AgNi) |
| Current rating: | 16 A/AC1; 1 HP 240 Vac, 1/2 HP 120 Vac; PD. B300 |
| Breaking capacity: | 4000 A/AC1, 384 W/DC1 |
| Switching voltage: | 250 V AC/24 V DC |
| Power dissipation (max.): | 1.2 W |
| Mechanical life: | 10.000.000 ops. |
| Electrical life (AC1): | 100.000 ops. |

| Other information | |
|---|--|
| Operating temperature: | -20 .. 55 °C (-4 .. 131 °F) |
| Storage temperature: | -30 .. 70 °C (-22 .. 158 °F) |
| Dielectric strength: | AC 4 kV (supply – output) |
| Operating position: | any |
| Mounting: | DIN rail EN 60715 |
| Protection degree: | IP40 front panel / IP20 terminals |
| Overvoltage category: | III. |
| Pollution degree: | 2 |
| Cross-wire section – solid/ stranded with ferrule (mm²): | max. 1x 2.5, 2x 1.5/ max. 1x 2.5 (AWG 14) |
| Dimensions: | 90 x 52 x 66 mm |
| Weight: | 66 g (2.32 oz) 64 g (2.26 oz) |
| Standards: | EN 60255-1, EN 60255-26, EN 60255-27 |

- The relay is designed to monitor undervoltage (HRN3-80), phase loss, sequence and asymmetry in 3-phase network.
- Power supply from monitored circuit.
- **HRN3-80:** Monitors the drop below the lower voltage level (Umin).
- **HRN3-80:** The lower level of Umin is set in % of the selected range.
- Wide range of monitored voltage 208 – 480 V.
- Adjustable time delay (to eliminate short-term voltage drops).
- Measures true root mean square value of the voltage - TRUE RMS.
- Adjustable level of asymmetry with the option to turn it off.

Description

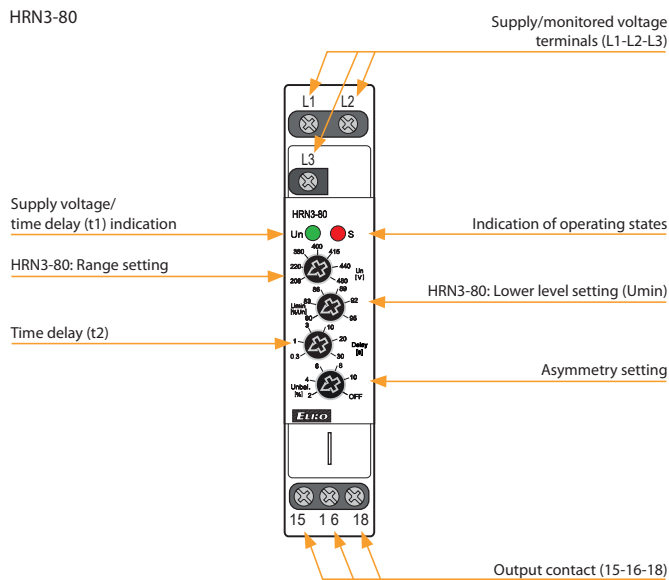

Connection

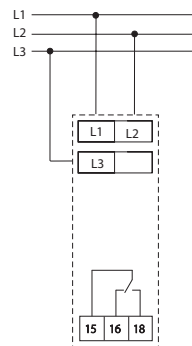

Symbol

HRN3-80

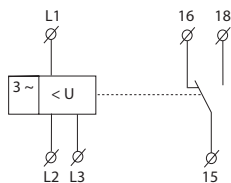

HRN3-81

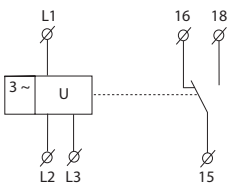

Function

Undervoltage:

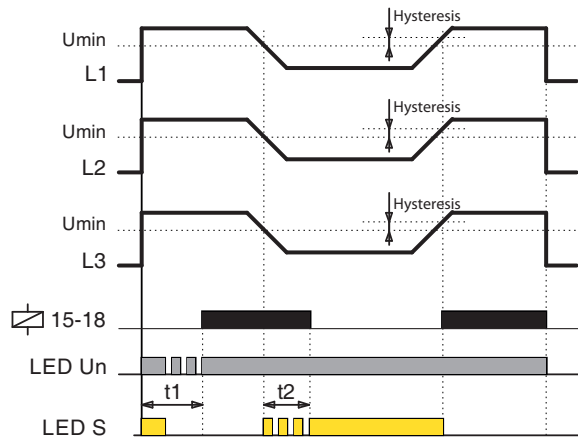

After connecting the device to the supply voltage, both LEDs on the panel will flash briefly.

If 3-phase voltage is connected to the monitoring relay and all conditions are met (correct voltage level, phase sequence and asymmetry), the output contact closes after the time delay t_1 elapsed.

During the time delay, the green „LED Un“ flashes, at the end of the delay „LED Un“ lights up continuously (OK state).

When the voltage drops below the lower level „Umin“ (HRN3-80 only), after the time delay t_2 has elapsed the green and red LEDs are lit. The output contact is open (fault state).

During the time delay t_2 , the red „LED S“ flashes quickly.

If the phase sequence is incorrect when the power supply is connected, after the time delay t_1 has elapsed the green and red LED flashes quickly. The output contact is open (fault state).

During the time delay t_1 , the green „LED Un“ flashes.

When the set phase asymmetry is exceeded, after the time delay t_2 has elapsed the green LED is lit and the red LED flashes briefly. The output contact is open (fault state).

During the time delay t_2 , the red „LED S“ flashes quickly.

In the event of phase failure, the output contact opens without a time delay t_2 (fault state), the green and red LEDs are lit.

The return from the fault state to the OK state occurs without a time delay.

Phase sequence:

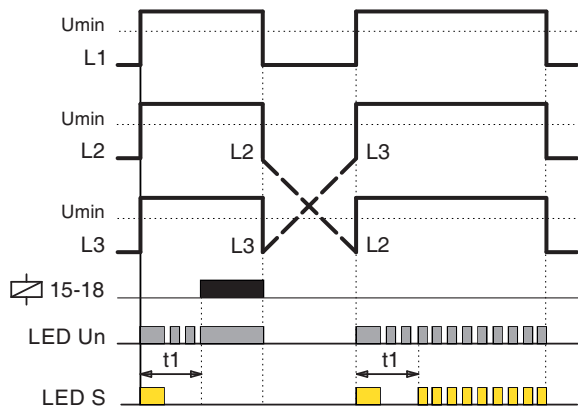

Phase asymmetry, failure:

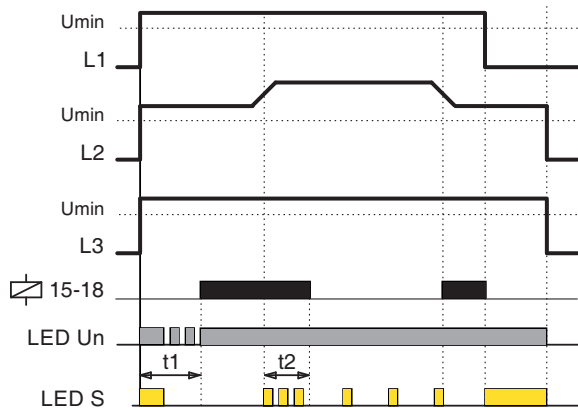

AC

**PRI-32**

Monitoring by current transformer (wire through an opening, galv. separated, without heat loss), adjust. current 1-20 A, multivoltage AC 24-240 and DC 24 V, output 8 A changeover. page 43

**PRI-34**

Multifunction current monitoring relay, measured by built-in current transformer, 5 rated currents (1 A-16 A), 1 A and 5 A range is suitable for external current transformer, AC/DC supply 24-240 V, output 8 A prep. page 44

**PRI-51**

Monitoring of current by in-built transformer, 7 ranges, range 5 A is suitable for current transformer, supply and output as PRI-32, difference from PRI-32: direct monitoring and finer ranges (higher sensitivity) = higher accuracy in measuring. page 46

| Type | Design | Supply voltage | Galvanically separated | Monitored parameters | | | | Setting | | | Description | Page | |
|---|--------|------------------------|------------------------|----------------------|---|-----|-----|---------|-------|------------|-------------|---|---------------|
| | | | | Phases | Range | > I | < I | < I > | Delay | Hysteresis | | | Memory faultS |
| PRI-32 | 1-M | AC 24-240 V DC 24 V | ● | 1 | AC 1 - 20 A | ● | x | x | x | x | x | Monitors the overflow of the current flowing through the guarded conductor, passed through the hole in the panel. | 43 |
| PRI-34/1A PRI-34/2A PRI-34/5A PRI-34/8A PRI-34/16A | 1-M | AC/DC 24-240 V | x | 1 | AC 0.05 - 1 A AC 0.1 - 2 A AC 0.25 - 5 A AC 0.4 - 8 A AC 0.8 - 16 A | ● | ● | ● | ● | ● | ● | Monitors the current depending on the selected function. The power supply is not galvanically isolated from the monitored current terminals. It is possible to connect ext. current transformer. | 44 |
| PRI-51/0.5A PRI-51/1A PRI-51/0.1-10A PRI-51/2A PRI-51/5A PRI-51/8A PRI-51/16A | 1-M | AC 24-240 V DC 24 V | ● | 1 | AC 0.05 - 0.5 A AC 0.1 - 1 A AC 0.1-10 A AC 0.2 - 2 A AC 0.5 - 5 A AC 0.8 - 8 A AC 1.6 - 16 A | ● | x | x | ● | x | x | Monitors the excess current flowing through the conductor connected to the monitored terminals. The power supply is galvanically isolated from the monitored current terminals. It is possible to connect ext. current transformer. | 46 |



EAN code
PRI-32: 8595188121965

| Technical parameters | | PRI-32 |
|---|--|--------|
| Supply circuit | | |
| Supply terminals: | A1 - A2 | |
| Voltage range: | AC 24 - 240 V, DC 24 V (AC 50-60 Hz) | |
| Burden: | max. 1.5 VA/1 W | |
| Max. dissipated power (Un + terminals): | 2 W | |
| Operating range: | -15 %; +10 % | |
| Measuring circuit | | |
| Current range: | 1 - 20 A (AC 50-60 Hz) | |
| Current adjustment: | potentiometer | |
| Accuracy | | |
| Setting accuracy (mech.): | 5 % | |
| Repeat accuracy: | < 1 % | |
| Temperature dependency: | < 0.1 %/°C (°F) | |
| Limit values tolerance: | 5 % | |
| Overload capacity: | max. 100 A/10 s | |
| Output | | |
| Number of contacts: | 1x changeover/SPDT (AgNi/Silver Alloy) | |
| Current rating: | 8 A/AC1; 1/3 HP 240 Vac, 1/4 HP 120 Vac; PD. B300 | |
| Breaking capacity: | 2000 VA/AC1, 240 W/DC | |
| Output indication: | red LED | |
| Mechanical life: | 60.000.000 ops. | |
| Electrical life (AC1): | 150.000 ops. | |
| Other information | | |
| Operating temperature: | -20 .. 55 °C (-4 .. 131 °F) | |
| Storage temperature: | -30 .. 70 °C (-22 .. 158 °F) | |
| Dielectrical strength: | 4 kV (supply - output) | |
| Operating position: | any | |
| Mounting: | DIN rail EN 60715 | |
| Protection degree: | IP40 from front panel/IP10 terminals | |
| Overvoltage category: | III. | |
| Pollution degree: | 2 | |
| Max. cable size (mm ²): | solid wire max. 2x 2.5 or 1x 4, with sleeve max. 1x 2.5 or 2x 1.5 (AWG 12) | |
| Dimensions: | 90 x 17.6 x 80.5 mm (3.5" x 0.7" x 3.2") | |
| Weight: | 75 g (2.6 oz.) | |
| Standards: | EN 60255-1, EN 60255-26, EN 60255-27 | |

- Current transformer is a part of the product. Inside this transformer there is a wire which senses the volume of flowing current.
- This construction reduces thermal stress of product when compared with conventional solutions with inbuilt shunt, and increases current range up to 20 Amps, and galvanically separates monitored circuit.
- For heating bars in sliding rails, heating cables, indication of current flow, controlling of 1-phase motor consumption,...
- Supply is galvanically separated from measuring current.
- Current exceeding - current flowing through monitored wire must not exceed 100 A.

Description

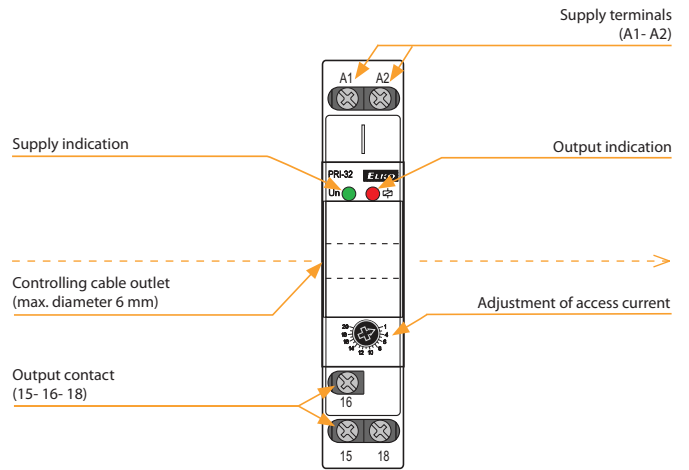

Function

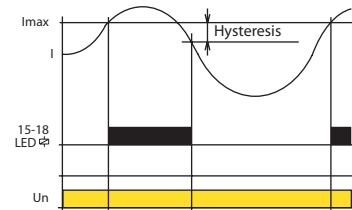

Monitoring relay PRI-32 serves to monitor current level in single phase AC circuits. Due to its fluent adjustment of release current, it is predestined for applications with necessity of current flow indication, and can be used as precedence relay. Output relay is off in normal state. In case the set current level is exceeded, it switches. Multivoltage supply is an advantage.

Connection

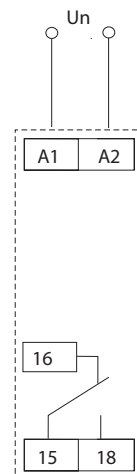

Symbol

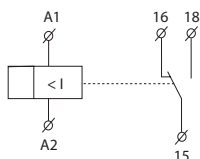



EAN code
 PRI-34/1A: 8595188188968
 PRI-34/2A: 8595188182829
 PRI-34/5A: 8595188182836
 PRI-34/8A: 8595188188975
 PRI-34/16A: 8595188182843



Technical parameters **PRI-34**

| Supply | |
|---------------------------|--------------------------------|
| Supply terminals: | A1 – A2 |
| Supply voltage: | AC/DC 24 – 240 V (AC 50-60 Hz) |
| Consumption (max.): | 3.8 VA/0.7 W |
| Supply voltage tolerance: | -15 %; +10 % |

| Measuring circuit | |
|---|--|
| Current range: | PRI-34/1A In - 1A PRI-34/2A In - 2A PRI-34/5A In - 5A PRI-34/8A In - 8A PRI-34/16A In - 16A (AC 50-60 Hz) |
| Max. permanent current peak overload (1 s): | PRI-34/1A 2A/10A PRI-34/2A 4A/10A PRI-34/5A 10A/16A PRI-34/8A 16A/16A PRI-34/16A 17A/32A |
| Upper level setting (Imax): | 10 – 100 %In |
| Lower level setting (Imin): | 5 – 95 %In |
| Time delay (d): | 300 ms |
| Time delay (t): | adjustable, 0.5 – 10 s |

| Accuracy | |
|---------------------------|---|
| Setting accuracy (mech.): | 5 % |
| Repeat accuracy: | < 1 % |
| Temperature dependency: | < 0.1 %/°C |
| Limit values tolerance: | 5 % |
| Hysteresis (fault to OK): | 5 % (function O1, U1, W) Imax – Imin (function O2, U2) |

| Output | |
|---------------------------|--|
| Contact type: | 1x changeover (AgNi) |
| Current rating: | 13 A/AC1; 1 HP 240 Vac, 1/2 HP 120 Vac; PD. B300 |
| Breaking capacity: | 4000 VA/AC1, 384 W/DC1 |
| Switching voltage: | 250 V AC/24 V DC |
| Power dissipation (max.): | 1.2 W |
| Mechanical life: | 10.000.000 ops. |
| Electrical life (AC1): | 100.000 ops. |

| Other information | |
|---|--|
| Operating temperature: | -20 .. +55 °C (-4 .. 131 °F) |
| Storage temperature: | -30 .. +70 °C (-22 .. 158 °F) |
| Dielectric strength: | AC 4 kV (supply – output) |
| Operating position: | any |
| Mounting: | DIN rail EN 60715 |
| Protection degree: | IP40 front panel / IP20 terminals |
| Oversvoltage category: | III. |
| Pollution degree: | 2 |
| Cross-wire section – solid/stranded with ferrule (mm²): | max. 1x 2.5, 2x 1.5/ max. 1x 2.5 (AWG 14) |
| Dimensions: | 90 x 17.6 x 64 mm (3.5" x 0.7" x 2.5") |
| Weight: | 60 g (2.15 oz) |
| Standards: | EN 60255-1, EN 60255-26, EN 60255-27 |

- It is used to monitor the value of alternating current, e.g.: motors, heating cables, lamps and other devices.
- Power supply and monitoring circuits are not galvanically isolated.
- Monitors current exceeding the upper current level (Imax) and falling below the lower current level (Imin) – according to the selected function.
- Smooth adjustment of both current levels.
- Adjustable time delay (to eliminate short-term current drops and spikes).
- Option to select functions with fault state memory (Latch).
- Measures true root mean square value of the current - TRUE RMS.
- Possibility to extend the current range using an external current transformer.

Description

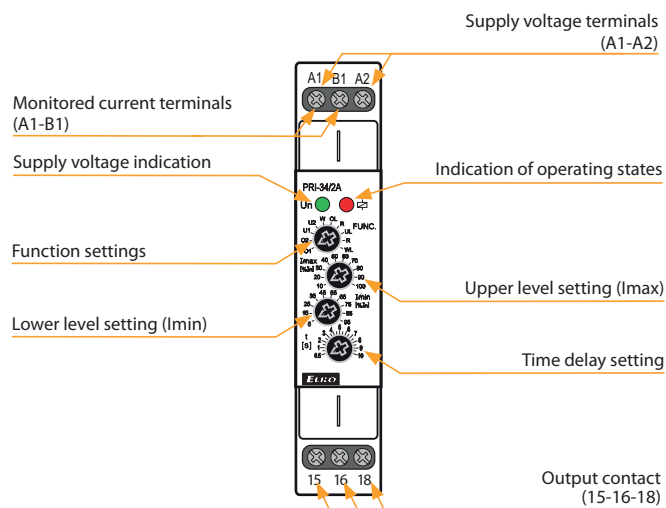

Connection

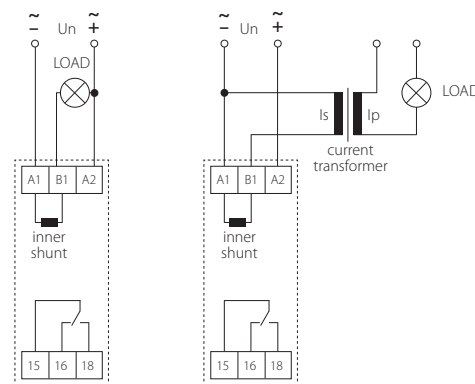

Indication of operating states

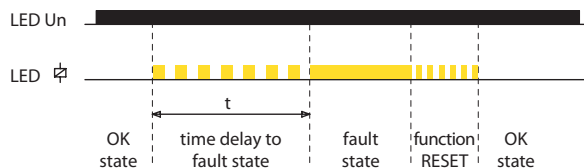

Function

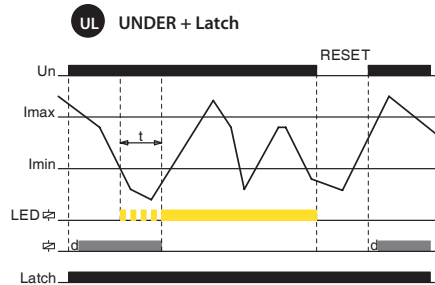
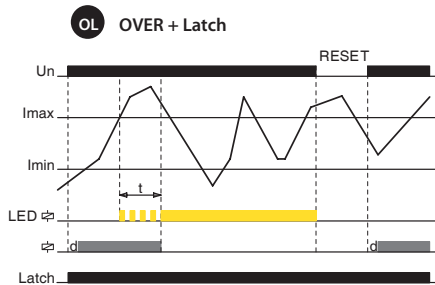
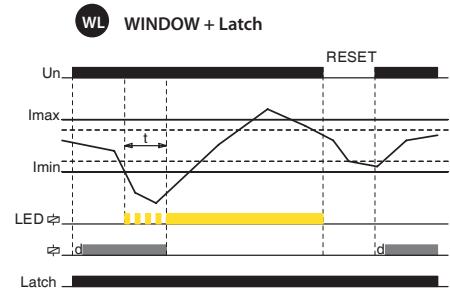
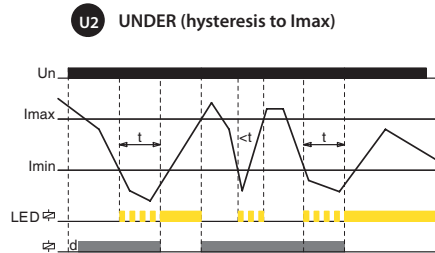
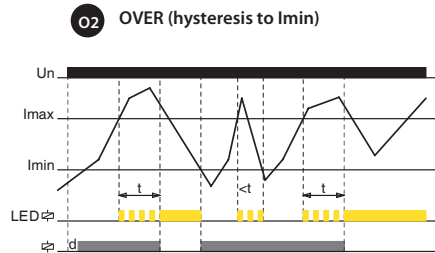
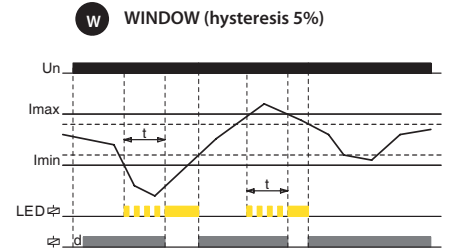
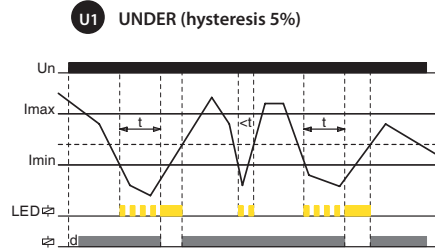
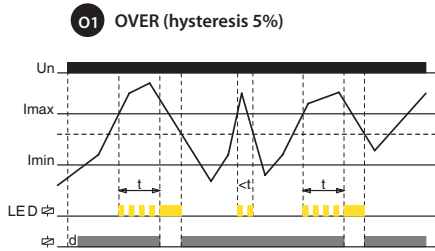

Graphs legend:
 t = time delay to fault state
 d = delay 0.3 s after connection of power supply (U_n)

OVER:

- If the value of the monitored current is lower than the set upper level „ I_{max} “, the output contact is closed. If the „ I_{max} “ is exceeded, the output contact will open after the set delay (fault state).
- If the current falls below the fixed hysteresis (function O1) or the set lower level „ I_{min} “ (function O2), the output contact will closes again.
- If the OL function (OVER + Latch) is selected, when the upper current level „ I_{max} “ is exceeded, the output contact remains open even when the current returns from the fault state.

Fault memory reset can be done in two ways:

- Short-term interruption of supply voltage.
- By setting the function switch to position R (RESET) or any function without memory fault.

The RESET state lasts for 3 s after switching the function switch from the R position to a function with memory fault (UL, OL, WL).

When moving to any other function from the R position, this delay does not apply.

UNDER:

- If the value of the monitored current is higher than the set lower level „ I_{min} “, the output contact is closed. When the current drops below the „ I_{min} “, output contact opens after the set delay (fault state).
- If the current exceeds the fixed hysteresis (function U1) or the set upper level „ I_{max} “ (function U2), the output contact closes again.
- If the UL function (UNDER + Latch) is selected, when the current drops below the lower level „ I_{min} “, the output contact remains open even when returning from the fault state. Fault memory reset can be done as in the previous case.

WINDOW:

- If the value of the monitored current is lower than upper level „ I_{max} “ and at the same time higher than lower level „ I_{min} “, the output contact in closed. If the „ I_{max} “ is exceeded or drops below the „ I_{min} “, output contact opens after the set delay (fault state).
- To return from the fault state, a fixed hysteresis is applied.
- If the WL function (WINDOW + Latch) is selected, the fault state is again stored in memory and output contact stays open, even when returning from the fault state. Fault memory reset can be done as in the previous cases.



EAN code
 PRI-51/1A: 8595188124904
 PRI-51/2A: 8595188124911
 PRI-51/5A: 8595188124928
 PRI-51/8A: 8595188124935
 PRI-51/16A: 8595188124942

| Technical parameters | | PRI-51 |
|---|--|--------|
| Supply circuit | | |
| Supply terminals: | A1 - A2 | |
| Voltage range: | AC 24 - 240 V and DC 24 V (AC 50-60 Hz) | |
| Burden: | max. 25 VA/1.6 W | |
| Max. dissipated power (Un + terminals): | 2.5 W | |
| Supply voltage tolerance: | -15 %; +10 % | |
| Measuring circuit | | |
| Load: | between B1 - B2 | |
| Current range: | PRI-51/1 A: AC 0.1-1 A PRI-51/8 A: AC 0.8-8 A PRI-51/2 A: AC 0.2-2 A PRI-51/16 A: AC 1.6-16 A PRI-51/5 A*: AC 0.5-5 A (AC 50-60 Hz) | |
| Max. permanent current: | PRI-51/1 A: 4 A PRI-51/2 A: 8 A PRI-51/5 A, PRI-51/8 A, PRI-51/16 A: 17 A | |
| Inrush overload <1ms: | 50 A | |
| Current adjustment: | potentiometer | |
| Time delay: | adjustable 0.5 - 10 s | |
| Accuracy | | |
| Setting accuracy (mechanical): | 5 % | |
| Repeat accuracy: | < 1 % | |
| Temperature dependency: | < 0.1 %/°C (°F) | |
| Limit values tolerance: | 5 % (10 % for 0.05 - 0.5 A and 0.1 - 10 A range) | |
| Hysteresis (fault to OK): | 5 % | |
| Mechanical life: | 60.000.000 op. | |
| Electrical life (AC1): | 150.000 op. | |
| Output | | |
| Number of contacts: | 1x changeover/SPDT (AgNi/Silver Alloy) | |
| Current rating: | 8 A/AC1; 1/3 HP 240 Vac, 1/4 HP 120 Vac; PD. B300 | |
| Breaking capacity: | 2000 VA/AC1, 240 W/DC | |
| Output indication: | red LED | |
| Other information | | |
| Operating temperature: | -20 .. 55 °C (-4 .. 131 °F) | |
| Storage temperature: | -30 .. 70 °C (-22 .. 158 °F) | |
| Dielectrical strength: | 4 kV (supply - output) | |
| Operating position: | any | |
| Mounting: | DIN rail EN 60715 | |
| Protection degree: | IP40 from front panel/IP10 terminals | |
| Overvoltage category: | III. | |
| Pollution degree: | 2 | |
| Max. cable size (mm ²): | solid wire max. 2x 2.5 or 1x 4, with sleeve max. 1x 2.5 or 2x 1.5 (AWG 12) | |
| Dimensions: | 90 x 17.6 x 64 mm (3.5" x 0.7" x 2.5") | |
| Weight: | 72 g (2.5 oz.) | |
| Standards: | EN 60255-1, EN 60255-26, EN 60255-27 | |

* applicable also for current transformer

- It serves for monitoring of heating in rail-switches, heating cables, consumption of 1-phase motors, indicates current flow.
- Flexible adjustment by potentiometer.
- Adjustable delay 0.5 - 10 s to eliminate short current peaks.
- It is possible to use for current scanning from current transformer.
- Supply is galvanically separated from measured current, it must be in the same phase.

Description

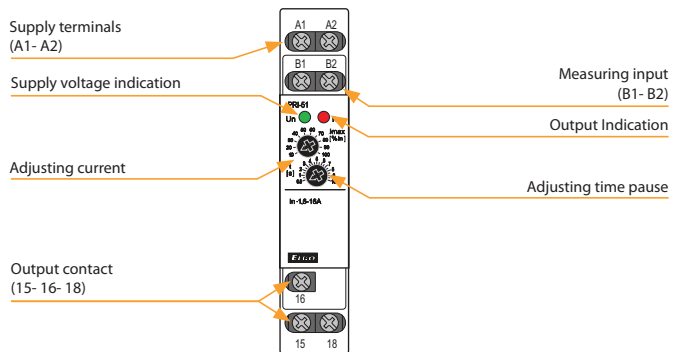

Function

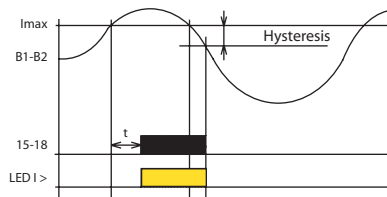

Monitoring relay PRI-51 serves to monitor current level in one-phase AC circuits. Gradual setting of actuating current of monitoring relay enables many different applications. Output relay is in normal state opened. After the set current level is reached, relay closes after the set delay (0.5 - 10 s). When returning from faulty to normal state there is a hysteresis (5 %). Multi-voltage of this relay is an advantage. It is possible to monitor load which doesn't have the same supply as monitoring relay PRI-51.

Range of PRI-51 can be increased by an external current transformer.

Connection

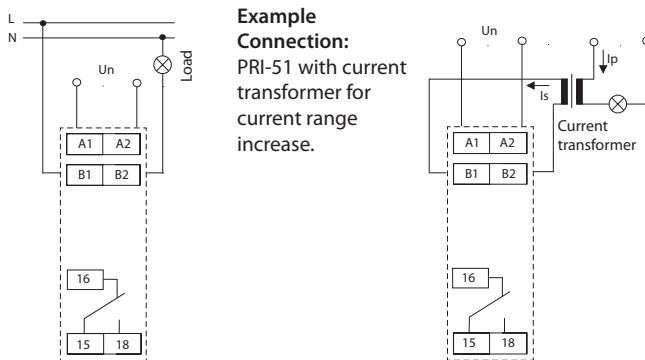

Symbol

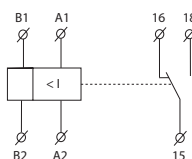

Example of an order

Always specify all reference name of current relay according to required range, for example PRI-51/5.

VS



VS116U

Supply voltage:
AC/DC 12-240 V
Output contact:
1x changeover/SPDT 16 A.
page 48



VS308U

Supply voltage:
AC/DC 12-240 V
Output contacts:
3x changeover/TPDT 8 A.
page 48

| Type | Design | Supply voltage | Output contact | Other features | | | Description | Page |
|--------|--------|------------------|----------------------------|------------------|---------|----------------|--------------------------|------|
| | | | | LED signal light | RC unit | Parallel diode | | |
| VS116U | 1M-DIN | AC/DC 12 – 240 V | 1x16 A changeover/ SPDT | ● | ● | ● | Universal supply voltage | 48 |
| VS308U | 1M-DIN | AC/DC 12 – 240 V | 3x 8 A changeover/ TPDT | ● | ● | ● | Universal supply voltage | |



- Power relay used for switching larger load output, strengthen or „multiplying“ contacts of the existing device.
- In the design 1-MODULE , DIN rail mounting, output status indicated by high intensity LED with choice of LED color (red, green, blue or white LED*).

| Technical parameters | VS116U | VS308U |
|--|--|---|
| Supply terminals: | A1 - A2 | |
| Voltage range: | AC/DC 12-240 V (50-60 Hz) | AC/DC 12-240 V (50-60 Hz) |
| Burden (max.): | AC 0.7 - 3 VA/DC 0.5 - 1.7 W | AC 0.7 - 3 VA/DC 0.5 - 1.7 W |
| Supply terminals: | x | x |
| Voltage range: | x | x |
| Burden: | x | x |
| Supply voltage tolerance: | -15%; +10% | |
| Max. dissipated power (Un + terminals): | 4 W | 3 W |
| Output | | |
| Number of contacts: | 1 x changeover/SPDT (AgSnO ₂) | 3 x changeover/TPDT (AgNi/Silver Alloy) |
| Current rating: | 16 A/AC1; 1 HP 240Vac, 1/2 HP 120Vac; PD. B300 | 8 A/AC1; 1/2 HP 240Vac; PD. B300 |
| Breaking capacity: | 4000VA/AC1, 384W/ DC | 2000VA/AC1, 192W/ DC |
| Inrush current: | 30 A/<3 s | 10 A/<3 s |
| Switching voltage: | 250V AC/24V DC | |
| Output indication: | high intensity LED | |
| Mechanical life: | 30.000.000 ops. | |
| Electrical life (AC1): | 100.000 ops. | 60.000 ops. |
| Time between switching: | min. 2s | |
| Other information | | |
| Operating temperature: | -20 .. +55 °C (-4 .. 131 °F) | |
| Storage temperature: | -30 .. +70 °C (-22 .. 158 °F) | |
| Dielectric strength: | 4 kV (supply-output) | |
| Operating position: | any | |
| Mounting: | DIN rail EN 60715 | |
| Protection degree: | IP40 from front panel/IP20 terminals | |
| Overvoltage category: | III. | |
| Pollution degree: | 2 | |
| Max. cable size (mm ²): | max. 1x 2.5 or 2x 1.5 max. 1x 2.5 (AWG 12) | |
| Dimensions: | 90 x 17.6 x 64 mm (3.5" x 0.7" x 2.5") | |
| Weight: | 59 g (2.1 oz.) | 80 g (2.8 oz.) |
| Standards: | EN 60669-1, EN 60669-2-1 | |

Description

VS116U

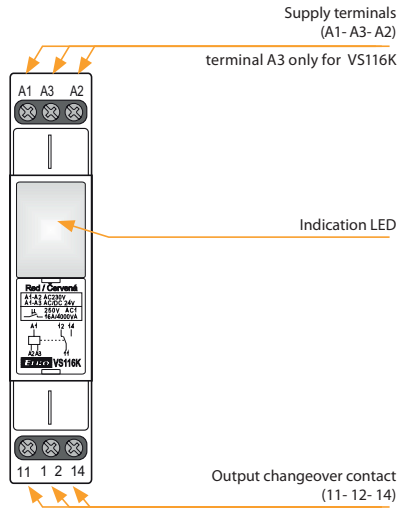

VS308U

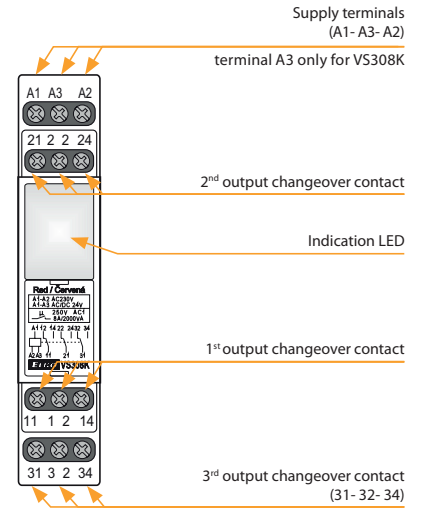

Symbol

VS116U

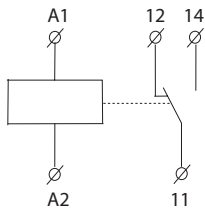

VS308U

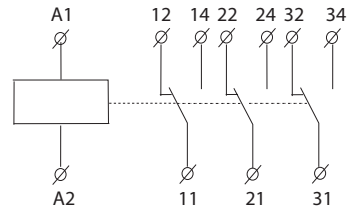

EAN codes

| | | | |
|--------------|---------------|--------------|---------------|
| VS116U/red | 8595188124607 | VS308U/red | 8595188130103 |
| VS116U/green | 8595188136433 | VS308U/green | 8595188136440 |
| VS116U/white | 8595188138482 | VS308U/white | 8595188138512 |
| VS116U/blue | 8595188138475 | VS308U/blue | 8595188138505 |

Order code

| | | |
|---|------------------------------|------------------------------|
|  | VS116U/red: 2460 | VS308U/red: 3010 |
|  | VS116U/green: 3643 | VS308U/green: 3644 |
|  | VS116U/white: 3848 | VS308U/white: 3851 |
|  | VS116U/blue: 3847 | VS308U/blue: 3850 |

Notes

Max. time of changeover of contact is 10 ms.

* possibility to choose blue and white color of LED for power relays line VS in case of minimal order quantity 100 pcs.

Installation contactors

Installation contactors VS



VS120

Number of contacts:
1x20 A. Configuration
of switching and
breaking contacts:
10, 01.
page 56



VS220

Number of contacts:
2x20 A. Configuration
of switching and
breaking contacts: 20,
11, 02.
page 56



VS425

Number of contacts:
4x25 A. Configuration
of switching and
breaking contacts:
40, 31, 22, 04.
page 56



VS440

Number of contacts:
4x40 A. Configuration
of switching and
breaking contacts:
40, 31, 22, 04.
page 56



VS463

Number of contacts:
4x63 A. Configuration
of switching and
breaking contacts:
40, 31, 22.
page 56

ALL IN ONE
daily
weekly
yearly
astro
PROGRAM

WEB
SERVER

Wi-Fi
2.4 GHz



EAN code
SHT-13/1: 8595188189071
SHT-13/2: 8595188184854

| Technical parameters | SHT-13/1 | SHT-13/2 |
|--|--|-------------------------------------|
| Supply terminals: | A1-A2 | |
| Supply voltage: | AC/DC 24 – 240 V (AC 50-60 Hz) | |
| Consumption (max.): | Wi-Fi "OFF" 0.5 W/2 VA "ON" 1 W/3 VA | |
| Supply voltage tolerance: | -15 %; +10 % | |
| Output | | |
| Contact type: | 1x changeover (AgSnO ₂) | 2x changeover (AgSnO ₂) |
| Current rating: | 16 A/AC1; 1 HP 240 Vac, 1/2 HP 120 Vac; PD. B300 | |
| Breaking capacity: | 4000 VA/AC1, 384 W/DC1 | |
| Inrush current: | 30 A/< 3 s | |
| Switching voltage: | 250 V AC/24 V DC | |
| Power dissipation (max.): | 1.2 W | 2.4 W |
| Mechanical life: | 30.000.000 ops. | |
| Electrical life (AC1): | 100.000 ops. | |
| Time circuit | | |
| Accuracy: | max. ±0.5 s/day at 23°C (73.4 °F) | |
| Min. switching interval: | 1 s | |
| Data retention time: | min. 10 years | |
| Set time backup: | up to half a year with 60 outages (CR 2032 - 3V) | |
| Program circuit | | |
| Number of memory locations: | 200 - time programs, 30 - holidays | |
| Program type: | daily, weekly, yearly, astro | |
| Displayed data: | LCD display with white backlight | |
| Settings via website: | by Wi-Fi (2.4 GHz) | |
| Other information | | |
| Operating temperature: | -20 .. +55 °C (-4 .. 131 °F) | |
| Storage temperature: | -30 .. +70 °C (-22 .. 158 °F) | |
| Dielectric strength: | | |
| supply – output | AC 4 kV | |
| output 1 – output 2 | AC 4 kV | |
| Operating position: | any | |
| Mounting: | DIN rail EN 60715 | |
| Protection degree: | IP40 front panel / IP20 terminals | |
| Overtoltage category: | III. | |
| Pollution degree: | 2 | |
| Cross-wire section – solid/ stranded with ferrule (mm ²): | max. 1x 2.5, 2x 1.5/ max. 1x 2.5 (AWG 14) | |
| Dimensions: | 90 x 35 x 64 mm (3.5" x 1.4" x 2.5") | |
| Weight: | 122 g (4.3 oz) | 135 g (4.8 oz) |
| Standards: | EN 61812-1 | |

Symbol

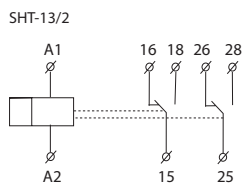
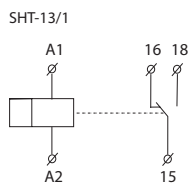

- All programs in one device (daily, weekly, yearly and astronomical).
- UNiversal supply voltage in range of AC/DC 24 – 240 V (AC 50-60 Hz).
- Simple setting after the first start-up.
- User replaceable battery to back up the set time during power outages.
- Built-in web server for setup and control via Wi-Fi connection.
- Time synchronization through NTP server (require internet connection).
- Possibility of permanent connection to the local network.
- New well-arranged display with white backlight.
- ASTROnomic program: manual entry of coordinates or selecting from one of more than 500 preset cities.
 - selection of days of the week
 - astro interrupt function (night break): controls the sunrise/sunset times and compares them with the set OFF/ON times
 - high position accuracy thanks to two decimal places in latitude/longitude
- One/two channel design (each with an operating hours counter).
- Pulse/cycle output mode.
- Transition of summer/winter time – AUTO or OFF.
- Sealable transparent front panel cover.
- PIN code protection against unauthorized changes.
- Wireless firmware update - **current version 1.46**

Description

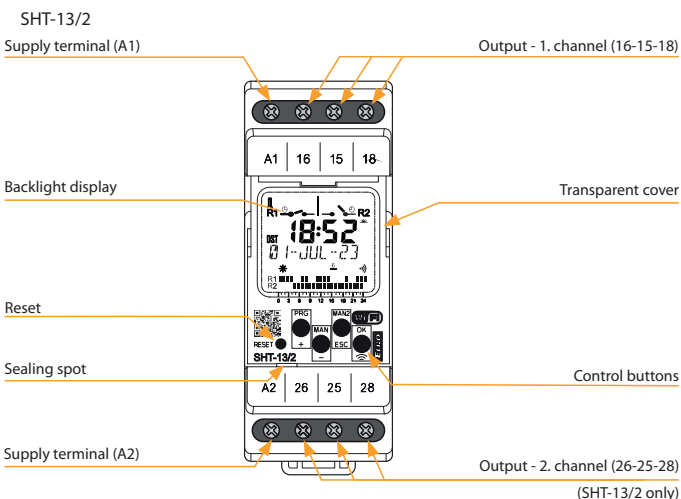

Description of displayed elements

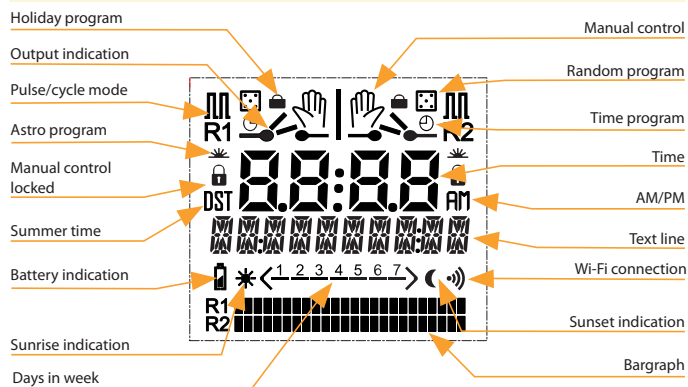

Connection

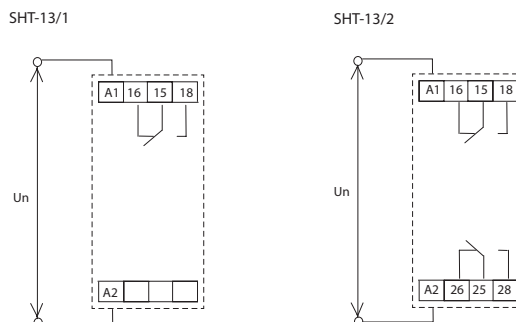

Switching power supplies DC, unregulated

Voltage 12 V



PS1M-15/12V
Input: AC 100 - 240 V
Output: DC 12 V stab.
load: 1.25 A/15 W.
- short circuit protection
- overload protection
- overvoltage protection
page 53



PS2M-24/12V
Input: AC 100 - 240 V
Output: DC 12 V stab.
Load: 2 A/24 W.
- short circuit protection
- overload protection
- overvoltage protection
page 53



PS3M-54/12V
Input: AC 100-240 V
Output: DC 12V stab.
Load: 4.5 A/54 W.
- short circuit protection
- overload protection
- overvoltage protection
page 53



PS4M-85/12V
Input: AC 100-240 V
Output: DC 12 V stab.
Load: 7.1 A/85 W.
- short circuit protection
- overload protection
- overvoltage protection
page 53



PS6M-135/12V
Input: AC 100-240 V
Output: DC 12 V stab.
Load: 10.2 A/122W.
- short circuit protection
- overload protection
- overvoltage protection
page 53

Voltage 24 V



PS1M-15/24V
Input: AC 100 - 240 V
Input: DC 24 V stab.
load: 0.625 A/15 W.
- short circuit protection
- overload protection
- overvoltage protection
page 53



PS2M-30/24V
Input: AC 100 - 240 V
Input: DC 24 V stable
load: 1.25 A/30 W.
- short circuit protection
- overload protection
- overvoltage protection
page 53



PS3M-60/24V
Input: AC 100-240 V
Input: DC 24 V stab.
load: 2.5 A/60 W.
- short circuit protection
- overload protection
- overvoltage protection
page 53



PS4M-92/24V
Input: AC 100 - 240 V
Input: DC 24 V stab.
load: 3.83 A/92 W
- short circuit protection
- overload protection
- overvoltage protection
page 53



PS6M-150/24V
Input: AC 100-240 V
Output: DC 24V stab.
Load: 5.3 A/127W.
- short circuit protection
- overload protection
- overvoltage protection
page 53

| Type | Design | Supply voltage | Galvanically isolated | Output | | | | | Output protection against | | | Description | Page |
|--------------|--------|----------------|-----------------------|--------|-----------|---------------|----------------|-------------|---------------------------|---------------|-------------|--|------|
| | | | | Analog | Switching | Stabilized DC | Output voltage | Loadability | Overcurrent | Short circuit | Temperature | | |
| PS1M-15/12V | 1M-DIN | AC 100 - 240 V | X | X | ● | ● | DC 12 V | 1.25 A | ● | ● | X | Fixed output voltage DC 12 V. Power: 15 W. | 53 |
| PS1M-15/24V | 1M-DIN | AC 100 - 240 V | X | X | ● | ● | DC 24 V | 0.625 A | ● | ● | X | Fixed output voltage DC 24 V. Power: 15 W. | |
| PS2M-24/12V | 2M-DIN | AC 100 - 240 V | X | X | ● | ● | DC 12 V | 2 A | ● | ● | X | Fixed output voltage DC 12 V. Power: 24 W. | |
| PS2M-30/24V | 2M-DIN | AC 100 - 240 V | X | X | ● | ● | DC 24 V | 1.25 A | ● | ● | X | Fixed output voltage DC 24 V. Power: 30 W. | |
| PS3M-54/12V | 3M-DIN | AC 100 - 240 V | X | X | ● | ● | DC 12 V | 4.5 A | ● | ● | X | Fixed output voltage DC 12 V. Power: 54 W. | |
| PS3M-60/24V | 3M-DIN | AC 100 - 240 V | X | X | ● | ● | DC 24 V | 2.5 A | ● | ● | X | Fixed output voltage DC 24 V. Power: 60 W. | |
| PS4M-85/12V | 4M-DIN | AC 100 - 240 V | X | X | ● | ● | DC 12 V | 7.1 A | ● | ● | X | Fixed output voltage DC 12V. Power: 85 W. | |
| PS4M-92/24V | 4M-DIN | AC 100 - 240 V | X | X | ● | ● | DC 24 V | 3.83 A | ● | ● | X | Fixed output voltage DC 24 V. Power: 92 W. | |
| PS6M-135/12V | 6M-DIN | AC 100 - 240 V | X | X | ● | ● | DC 12 V | 10.2 A | ● | ● | X | Fixed output voltage DC 12 V. Power: 122 W (120 V), 135 W (230 V) | |
| PS6M-150/24V | 6M-DIN | AC 100 - 240 V | X | X | ● | ● | DC 24 V | 5.3 A | ● | ● | X | Fixed output voltage DC 12V. Power: 85 W. | |



- Rated output voltage 12 or 24V DC with the possibility of regulation.
- High efficiency of up to 90%.
- Low ripple & noise.
- Protection: Over load , Over voltage and Short circuit.
- Continuously adjustable output voltage to adapt to the specific application, e.g. the need to compensate for the voltage drop caused by the length of the line.

EAN code
 PS1M-15/12V: 8595188180474
 PS1M-15/24V: 8595188180481
 PS2M-24/12V: 8595188180498
 PS2M-30/24V: 8595188180504
 PS3M-54/12V: 8595188180511
 PS3M-60/24V: 8595188180528
 PS4M-85/12V: 8595188180535
 PS4M-92/24V: 8595188180542
 PS6M-135/12V: 8595188199698
 PS6M-150/24V: 8595188199704

| Technical parameters | PS1M-15/12V | PS1M-15/24V | PS2M-24/12V | PS2M-30/24V | PS3M-54/12V | PS3M-60/24V | PS4M-85/12V | PS4M-92/24V | PS6M-135/12V* | PS6M-150/24V* |
|------------------------------------|--|--------------------------------------|--|--------------------------------------|--|--------------|--|-------------|--|-------------------------|
| Input | | | | | | | | | | |
| Voltage range: | AC 100 - 240 V (50/60 Hz), DC 145 - 330 V | | | | | | | | | |
| Tolerance: | ± 10% | | | | | | | | | |
| Efficiency: | 85% | 86% | 88% | 89% | 88% | 90% | 88% | 90% | 89% | 90% |
| Consumption without load (max.): | 0.3W/4VA | 0.5W/4VA | 0.3W/8VA | 0.4W/8VA | 0.3W/7VA | 0.5W/6.5VA | 0.4W/11VA | 0.1W/12VA | TBD | TBD |
| Consumption with full load (max.): | 16W/30VA | 17.5W/32VA | 30W/50VA | 33W/60VA | 60W/95VA | 70W/111VA | 95W/150VA | 105W/160VA | TBD | TBD |
| Inrush current:**** | max. 25A at 115V AC/60Hz max. 45A at 240V AC/50Hz | | | | max. 30A at 115V AC/60Hz max. 60A at 240V AC/50Hz | | max. 35A at 115V AC/60Hz max. 70A at 240V AC/50Hz | | max. 35A at 115V AC/60Hz max. 70A at 240V AC/50Hz | |
| Output | | | | | | | | | | |
| Rated voltage:** | 12V DC | 24V DC | 12V DC | 24V DC | 12V DC | 24V DC | 12V DC | 24V DC | 12V DC | 24V DC |
| Voltage setting range: | 11 - 13V | 23 - 25V | 11 - 13V | 23 - 25V | 11.4 - 12.6V | 22.8 - 25.2V | 11 - 13V | 23 - 25V | 11 - 13V | 23 - 25V |
| Rated current: | 1.25A | 0.625A | 2A | 1.25A | 4.5A | 2.5A | 7.1A | 3.83A | 11.3A/230V 10.2A/120V | 6.25A/230V 5.3A/120V |
| Rated power: | 15W | 15W | 24W | 30W | 54W | 60W | 85W | 92W | 135W | 150W |
| Ripple & Noise: | 120mV | 150mV | 120mV | 150mV | 120mV | 150mV | 120mV | 150mV | 100mV | 150mV |
| Output indication: | blue LED | | blue LED | | green LED | | blue LED | | blue LED | |
| Tolerance of output voltage: | 5 % | | | | | | | | | |
| Overload protection: | from 130 % - 200% rated output power | | | | | | | | | |
| Overvoltage protection: | from 110 % - 145% rated output power | | | | | | | | from 105 % - 135% rated output power | |
| Overcurrent protection: | from 110 % - 180% rated output power | | | | | | | | | |
| Short circuit protection: | temporarily disconnecting the output | | | | | | | | | |
| Other information | | | | | | | | | | |
| Operating temperature:*** | -20 .. +50°C (-4 .. 122 °F) | | | | | | | | | |
| Operating humidity: | 20% ~ 90% RH non-condensing | | | | | | | | | |
| Storage temperature: | -40 .. +80°C (-40 .. 176 °F) | | | | | | | | | |
| Dielectric strength: | 3kV AC | | | | | | | | | |
| Insulation resistance: | 100M Ω/500V DC/25°C (77°F)/70% RH | | | | | | | | | |
| Overvoltage category: | III. | | | | | | | | | |
| Pollution degree: | 2 | | | | | | | | | |
| Max. cable size: | max. 1x 2.5 mm ² , max. 2x 1.5 mm ² solid wire/with sleeve max. 1x 2,5 mm ² | | | | | | | | | |
| Terminal torque: | | | | | | | | | | |
| input terminals | 0.5 Nm | | 0.3 Nm | | 0.3 Nm | | 0.3 Nm | | 0.3 Nm | |
| output terminals | 0.5 Nm | | | | | | | | | |
| Protection degree: | IP20 | | | | | | | | | |
| MTBF: | 200 000 hours minimum, full load at 25°C ambient temperature | | | | | | | | | |
| Mounting: | DIN rail EN 60715 | | | | | | | | | |
| Dimensions: | 90 x 18 x 58 mm (3.5" x 0.71" x 2.3") | 90 x 35 x 58 mm (3.5" x 1.4" x 2.3") | 90 x 52.5 x 58 mm (3.5" x 2.1" x 2.3") | 90 x 70 x 58 mm (3.5" x 2.8" x 2.3") | 90 x 105 x 58 mm (3.5" x 4.1" x 2.3") | | | | | |
| Weight: | 78 g (2.8 oz) | 120 g (4.2 oz) | 190 g (6.7 oz) | 270 g (9.5 oz) | 380 g (13.8 oz) | | | | | |
| Standards: | IEC60950-1, UL62368-1, TUV EN61558-2-16 | | | | | | | | | |

* PS6M-135/12V & PS6M-150/24V on request

** different rated voltage on request: PS1M, PS2M, PS3M - 5V, 15V, 48V; PS4M, PS6M - 15V, 48V

*** PS6M - max. operating temperature limited to 45°C (113°F)

**** the stated values are valid for the full load from the source



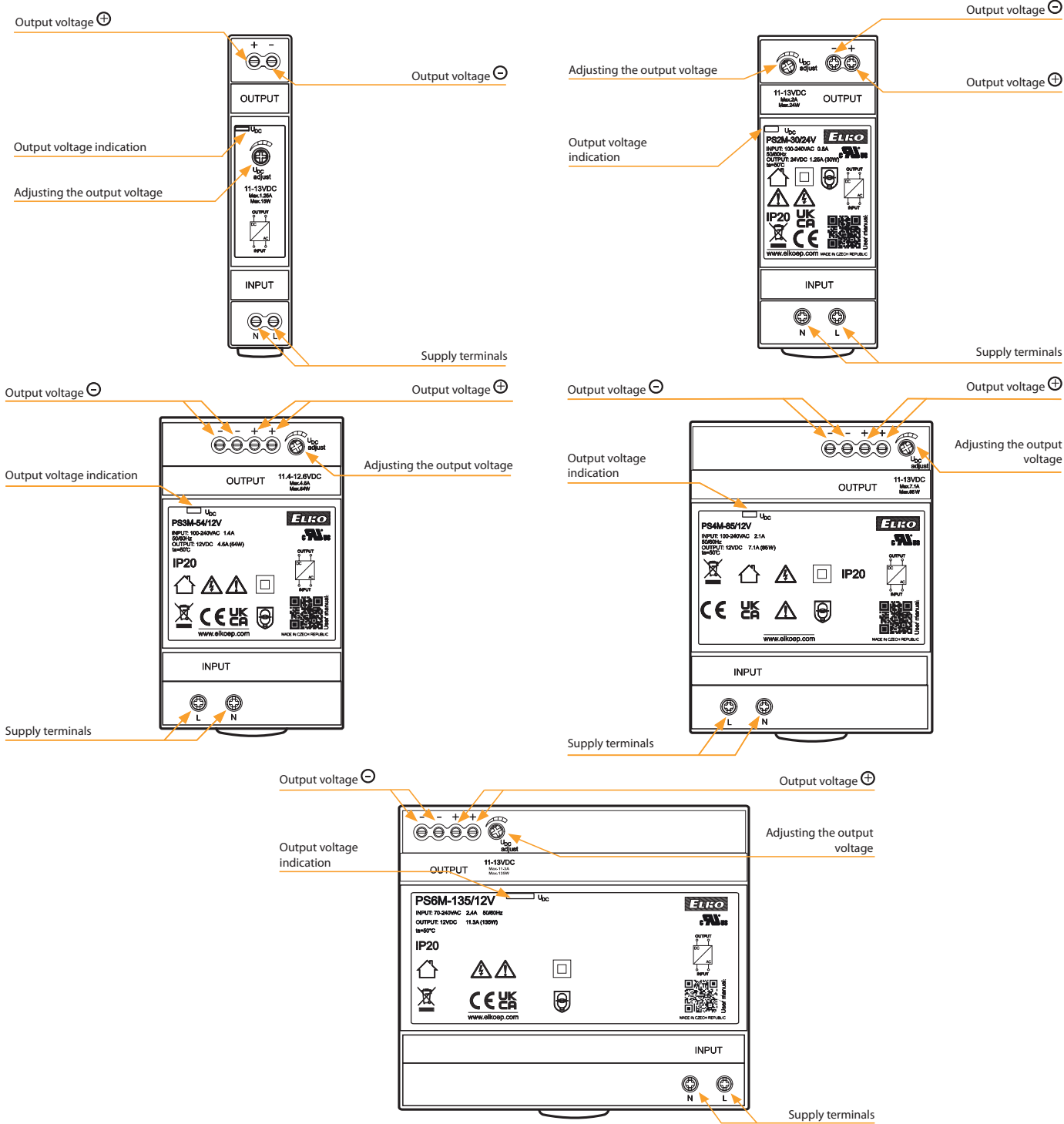

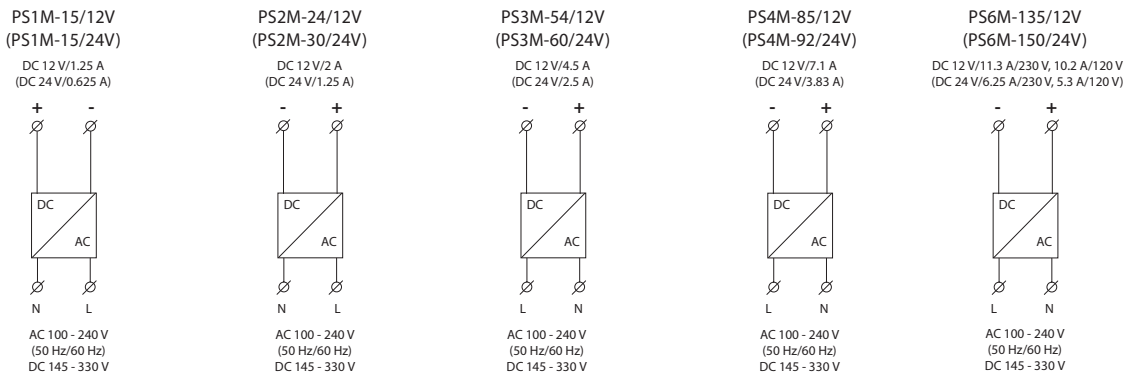

Description



Connection



Explanation of symbols

| TYPE OF LOAD (symbols) | bulbs, halogen lamps | low-voltage el.bulbs 12/24V wound transformers | low-voltage el.bulbs 12/24V electronic transformers | ESL dimmable compact fluorescent lamps | Dimmable LED bulbs (triac dimmer) | Dimmable LED bulbs (dimmer with MOSFET) |
|------------------------|---|---|---|--|---|---|
| |  |  |  |  |  |  |
| | R | L | C | ESL | LED ¹ | LED ² |

Demonstrated symbols are informative

Explanation:



R, L, C,
ESL, LED

Dimmer with designated load:

R - resistive

L - inductive

C - capacitive

ESL - energy saving bulbs

LED¹ - dimmable LED bulbs, designed for dimmers with phase-controlled rising edge (triac dimmers)

LED² - dimmable LED bulbs designed for dimmers with phase or phase-to-phase phase control (dimmers with MOSFET).

IPxx protection - under normal conditions: normal conditions are understood as such conditions of operating an electrical device, installation and power supply network for which the entire device is designed, produced and installed. Upon these normal conditions of use and upon normal maintenance, all protective devices must be effective throughout the entire expected service life of the product.

Recommendation for mounting modular dimmers: leave a gap of min. 0.5 module (approx. 9 mm / 0.4") on side of the device to ensure better cooling of the device.



EAN code
see page 38

- For switching electric circuits, especially for resistive loads and 3-phase induction motors
- Number of contacts: VS120 - 1, VS220 - 2, VS325, VS340, VS363 - 3, VS425, VS440, VS463 - 4
- It is produced in configuration of switching and breaking contacts:
VS120: 10, 01 VS220: 20, 11, 02
VS325: 30 VS425: 40, 31, 22, 13 04
VS340: 30 VS440: 40, 31, 22, 04
VS363: 30 VS463: 40, 31, 22
- It is possible to connect auxiliary contacts VSK to contactors VS425, VS440, VS463

| Technical parameters | VS120 | VS220 | VS325/VS425 | VS340/VS440 | VS363/VS463 |
|--|---|--|--|--|--|
| Rated insulation voltage (Ui): | 230 V | 230 V | 440 V | 440 V | 440 V |
| Rated thermo-current I _{th} (in AC): | 20 A | 20 A | 25 A | 40 A | 63 A |
| Voltage range: | 50/60 Hz | 50/60 Hz | 50/60 Hz | 50/60 Hz | 50/60 Hz |
| Switched operation | | | | | |
| AC-1 for 400 V, 3 phase: | x | x | 16 kW | 26 kW | 40 kW |
| AC-1 for 230 V: | 4 kW, 1 phase | 4 kW, 1 phase | 9 kW, 3 phase | 16 kW, 3 phase | 24 kW, 3 phase |
| AC-3 for 400 V, 3 phase: | x | x | 4 kW | 11 kW | 15 kW |
| AC-3 for 230 V: | 1.3 kW only NO, 1 phase | 1.3 kW only NO, 1 phase | 2.2 kW, 3 phase | 5.5 kW, 3 phase | 8.5 kW, 3 phase |
| AC-7a for 400 V, 3 phase: | x | x | 16 kW | 26 kW | 40 kW |
| AC-7a for 230 V: | 4 kW, 1 phase | 4 kW, 1 phase | 9 kW, 3 phase | 16 kW, 3 phase | 24 kW, 3 phase |
| AC-7b for 400 V, 3 phase: | x | x | 4 kW | 11 kW | 15 kW |
| AC-7b for 230 V: | 1.3 kW only NO, 1 phase | 1.3 kW only NO, 1 phase | 2.2 kW, 3 phase | 5.5 kW, 3 phase | 8.5 kW, 3 phase |
| AC-15 for 400 V, 1 phase: | 4 A | 4 A | 4 A | 4 A | 4 A |
| AC-15 for 230 V, 1 phase: | 6 A | 6 A | 6 A | 6 A | 6 A |
| DC1 U _e = 24/110/220 V: | 20/6/0.6 A | 20/6/0.6 A | 25/6/0.6 A | 40/4/1.2 A | 63/4/1.2 A |
| Loadability of modular contactors see page 58 | | | | | |
| The max. number of switching for max. load: | 600 switch/hr. | 600 switch/hr. | 600 switch/hr. | 600 switch/hr. | 600 switch/hr. |
| Electrical life in 230/400 V | | | | | |
| AC-1- resistive load : | 200.000 | 200.000 | 200.000 | 100.000 | 100.000 |
| AC-3-power load: | 300.000 | 300.000 | 500.000 | 500.000 | 150.000 |
| AC-5a - high-intensity discharge lamp: | 100.000 by 30 μF | 100.000 by 30 μF | 100.000 by 36 μF | 100.000 by 220 μF | 100.000 by 330 μF |
| AC-5b - incandescent lamps: | 100.000 by 2 kW | 100.000 by 2 kW | 100.000 by 2 kW | 100.000 by 4 kW | 100.000 by 5 kW |
| AC-7a - resistive household devices: | 200.000 | 200.000 | 200.000 | 100.000 | 100.000 |
| AC-7b - inductive household devices: | 300.000 | 300.000 | 300.000 | 150.000 | 150.000 |
| Minimal load: | ≥ 17 V, ≥ 50 mA | ≥ 17 V, ≥ 50 mA | ≥ 17 V, ≥ 50 mA | ≥ 17 V, ≥ 50 mA | ≥ 24 V, ≥ 100 mA |
| Short circuit protection with the fuse char. aM: | 20 A | 20 A | 25 A | 63 A | 80 A |
| Coordination Type according EN 60 947-4-1: | 2 | 2 | 2 | 2 | 2 |
| Dielectric strength: | 4 kV | 4 kV | 4 kV | 4 kV | 4 kV |
| Contacts - max. cable size | | | | | |
| Solid conductor: | AWG 7 (10 mm ²) | AWG 7 (10 mm ²) | AWG 10 (10 mm ²) | AWG 10 (25 mm ²) | AWG 10 (25 mm ²) |
| Stranded conductor: | AWG 8 (6 mm ²) | AWG 8 (6 mm ²) | AWG 8 (6 mm ²) | AWG 4 (16 mm ²) | AWG 4 (16 mm ²) |
| Maximal torque: | 1.2 Nm (10.62 lbf.in) | 1.2 Nm (10.62 lbf.in) | 1.2 Nm (10.62 lbf.in) | 3.5 Nm (30.95 lbf.in) | 3.5 Nm (30.95 lbf.in) |
| Coil - max. cable size | | | | | |
| Solid conductor: | AWG 14 (2.5 mm ²) | AWG 14 (2.5 mm ²) | AWG 14 (2.5 mm ²) | AWG 14 (2.5 mm ²) | AWG 14 (2.5 mm ²) |
| Stranded conductor: | AWG 14 (2.5 mm ²) | AWG 14 (2.5 mm ²) | AWG 14 (2.5 mm ²) | AWG 14 (2.5 mm ²) | AWG 14 (2.5 mm ²) |
| Max. torque: | 0.6 Nm (5.31 lbf.in) | 0.6 Nm (5.31 lbf.in) | 0.6 Nm (5.31 lbf.in) | 0.6 Nm (5.31 lbf.in) | 0.6 Nm (5.31 lbf.in) |
| Operating | | | | | |
| Coil control voltage: | AC/DC 24 V, 120 V, 230 V | AC/DC 24 V, 48 V, 120 V, 230 V | AC/DC 24 V, 48 V, 120 V, 230 V | AC/DC 24 V, 120 V, 230 V | AC/DC 24 V, 48 V, 120 V, 230 V |
| Coil permanent supply +/- 10 %: | 2.1 VA/2.1 W | 2.1 VA/2.1 W | 2.6 VA/2.6 W * | 5 VA/5 W | 5 VA/5 W |
| Coil gear supply +/- 10 %: | 2.1 VA/2.1 W | 2.1 VA/2.1 W | 2.6 VA/2.6 W * | 5 VA/5 W | 5 VA/5 W |
| Mounting side-by-side: | max. 2 contactors** | max. 2 contactors** | max. 2 contactors** | max. 2 contactors** | max. 2 contactors** |
| Operational temperature: | -5 .. +55 °C (23 .. 131 °F) | | | | |
| Storing temperature: | -30 .. +80 °C (-22 .. 176 °F) | | | | |
| Weight: | 120 g (4.2 oz.) | 130 g (4.6 oz.) | 213 g (7.5 oz.) | 400 g (14 oz.) | 400 g (14 oz.) |
| Dimensions: | 17.5 x 85 x 60 mm (0.7" x 3.35" x 2.4") | 17.5 x 85 x 60 mm (0.7" x 3.35" x 2.4") | 35 x 85 x 60 mm (1.4" x 3.35" x 2.4") | 53.3 x 84 x 60 mm (2.1" x 3.31" x 2.4") | 53.3 x 84 x 60 mm (2.1" x 3.31" x 2.4") |
| Standards: | IEC 60947-4-1, IEC 60947-5-1, IEC 61095, EN 60947-4-1, EN 60947-5-1, EN 61095, EN 60947-1 | | | | |

* 3.8 VA/3.8 W for -04 version of contacts

** Note: If several contactors are mounted close together a gap of 9 mm must be maintained between every other contactor.

*** HP rating: VS120 & VS220: 1-phase 1 HP|240 Vac, 1/3 HP|120 Vac; PD. B300, P300

VS325 & VS425: 1-phase 1 HP|240 Vac, 1/3 HP|120 Vac; 3-phase 3 HP|240 Vac, 5 HP|460 Vac; PD. B300, P300

VS340 & VS440: 1-phase 3 HP|240 Vac, 1 HP|120 Vac; 3-phase 7 HP|240 Vac, 15 HP|460 Vac; PD. B300, P300

VS363 & VS463: 1-phase 5 HP|240 Vac, 2 HP|120 Vac; 3-phase 10 HP|240 Vac, 20 HP|460 Vac; PD. B300, P300

VS120

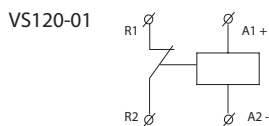
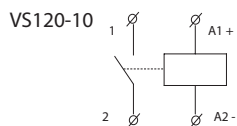

VS325

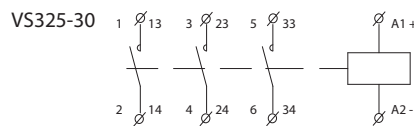

VS220

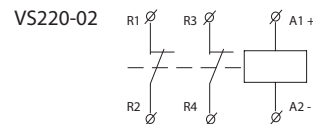
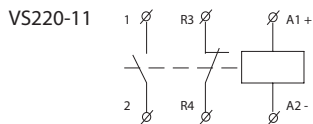
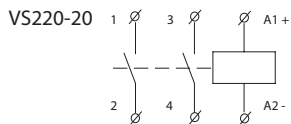

VS340

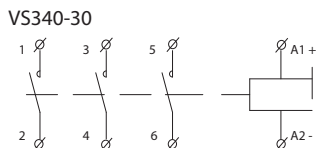

VS425

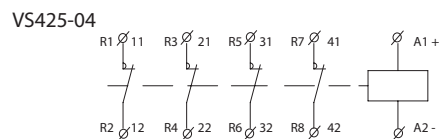
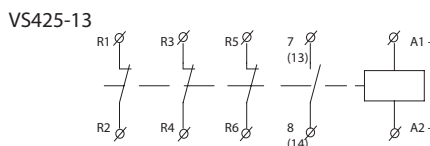
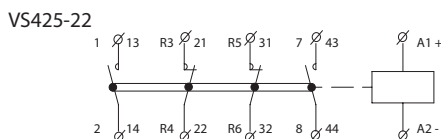
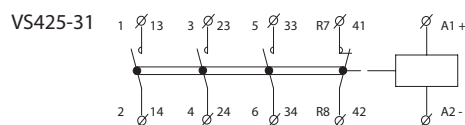
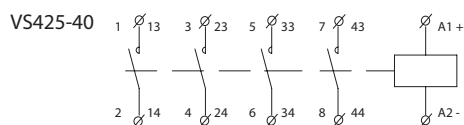

VS440

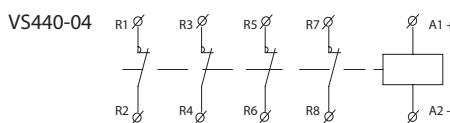
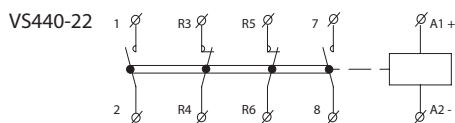
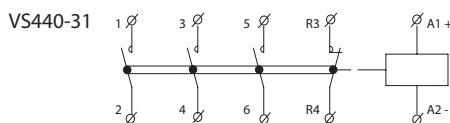
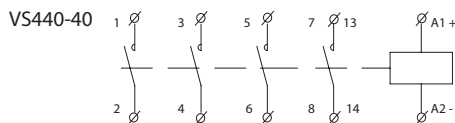

VS363

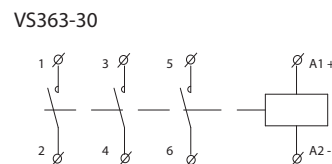

VS463

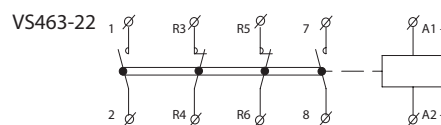
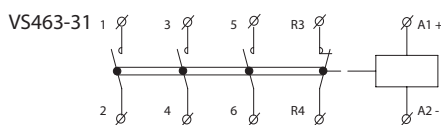
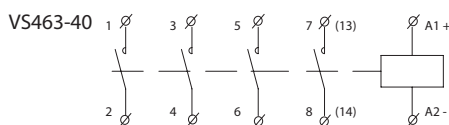

Auxiliary contacts for VS425, VS440, VS463

Datas of auxiliary contacts for VSK-11 and VSK-20

| | |
|--|---|
| Ambient temperature: | -5 .. +55 °C (23 .. 131 °F) |
| Rated insulation voltage (Ui): | 500 V |
| Dielectric strength: | 4 kV |
| Rated current 230 V (AC 15): | 6 A |
| Rated current 400 V (AC 15): | 4 A |
| Max. switching frequency: | 6 A |
| The max. number of switching for max. load: | 600 sep./hod. |
| Minimal load: | ≥ 12 V, ≥ 10 mA |
| Short circuit protection with the fuse char. aM: | 6 A |
| Solid/Stranded conductor (max): | 2.5 mm ² /2.5 mm ² (AWG 10) |
| Maximal torque: | 0.8 Nm |
| Weight: | 10 g (0.35 oz.) |
| Dimensions: | 10 x 85 x 60 mm (0.4" x 3.35" x 2.4") |

Connection of auxiliary contact VSK-11 and VSK-20

EAN code
see page 59

VSK-11



VSK-20

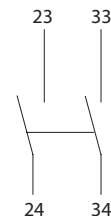

Number of lights on one contactor's contact

| TYPE OF LIGHT | OUTPUT (W) | I (A) | VS120 | VS220 | VS425 | VS440 | VS463 |
|--|------------|-------|--------|--------|--------|---------|---------|
| Incandescent lamps | 60 | 0.26 | 33 | 33 | 33 | 65 | 85 |
| | 100 | 0.43 | 20 | 20 | 20 | 40 | 50 |
| | 200 | 0.87 | 10 | 10 | 10 | 20 | 25 |
| | 500 | 2.17 | 3 | 3 | 3 | 8 | 10 |
| | 1000 | 4.35 | 1 | 1 | 1 | 4 | 5 |
| Flourescent lamps | 18 | 0.37 | 22 | 22 | 24 | 90 | 140 |
| | 24 | 0.35 | 22 | 22 | 24 | 90 | 140 |
| | 36 | 0.43 | 17 | 17 | 20 | 65 | 95 |
| | 58 | 0.67 | 14 | 14 | 17 | 45 | 70 |
| Flourescent lamps lead-lag circuit | 18 | 0.11 | 2 x 30 | 2 x 30 | 2 x 40 | 2 x 100 | 2 x 150 |
| | 24 | 0.14 | 2 x 24 | 2 x 24 | 2 x 31 | 2 x 78 | 2 x 118 |
| | 36 | 0.22 | 2 x 17 | 2 x 17 | 2 x 24 | 2 x 65 | 2 x 95 |
| | 58 | 0.35 | 2 x 10 | 2 x 10 | 2 x 14 | 2 x 40 | 2 x 60 |
| Flourescent lamps parallel correction | 18 | 0.12 | 7 | 7 | 8 | 48 | 73 |
| | 24 | 0.15 | 7 | 7 | 8 | 48 | 73 |
| | 36 | 0.2 | 7 | 7 | 8 | 48 | 73 |
| | 58 | 0.32 | 4 | 4 | 5 | 31 | 47 |
| Flourescent lamps with electronic ballast units (EVG) | 1 x 18 | 0.09 | 25 | 25 | 35 | 100 | 140 |
| | 1 x 36 | 0.16 | 15 | 15 | 20 | 52 | 75 |
| | 1 x 58 | 0.25 | 14 | 14 | 19 | 50 | 72 |
| | 2 x 18 | 0.17 | 12 | 12 | 17 | 50 | 70 |
| | 2 x 36 | 0.32 | 7 | 7 | 10 | 26 | 38 |
| High-pressure mercury-vapour lamps uncorrected | 50 | 0.61 | 14 | 14 | 18 | 38 | 55 |
| | 80 | 0.8 | 10 | 10 | 13 | 29 | 42 |
| | 125 | 1.15 | 7 | 7 | 9 | 20 | 29 |
| | 250 | 2.15 | 4 | 4 | 5 | 10 | 15 |
| | 400 | 3.25 | 2 | 2 | 3 | 7 | 10 |
| | 700 | 5.4 | 1 | 1 | 2 | 4 | 6 |
| High-pressure mercury-vapour lamps parallel correction | 50 | 0.28 | 4 | 4 | 5 | 31 | 47 |
| | 80 | 0.41 | 4 | 4 | 5 | 27 | 41 |
| | 125 | 0.65 | 3 | 3 | 4 | 22 | 33 |
| | 250 | 1.22 | 1 | 1 | 2 | 12 | 18 |
| | 400 | 1.95 | 1 | 1 | 1 | 9 | 13 |
| | 700 | 3.45 | - | - | - | 5 | 7 |
| Halogen metal vapour lamps uncorrected | 1000 | 4.8 | - | - | - | 4 | 5 |
| | 35 | 0.53 | 18 | 18 | 22 | 43 | 60 |
| | 70 | 1 | 10 | 10 | 12 | 23 | 32 |
| | 150 | 1.8 | 5 | 5 | 7 | 12 | 18 |
| | 250 | 3 | 3 | 3 | 4 | 7 | 10 |
| | 400 | 3.5 | 3 | 3 | 3 | 6 | 9 |
| | 1000 | 9.5 | 1 | 1 | 1 | 2 | 3 |
| Halogen metal-vapour lamps parallel correction | 2000 | 16.5 | - | - | - | 1 | 1 |
| | 35 | 0.25 | 5 | 5 | 6 | 36 | 50 |
| | 70 | 0.45 | 2 | 2 | 3 | 18 | 25 |
| | 150 | 0.75 | 1 | 1 | 1 | 11 | 15 |
| | 250 | 1.5 | - | - | 1 | 6 | 9 |
| | 400 | 2.5 | - | - | 1 | 6 | 8 |
| | 1000 | 5.8 | - | - | - | 2 | 3 |
| High-pressure sodium-vapour lamps uncorrected | 2000 | 11.5 | - | - | - | 1 | 2 |
| | 150 | 1.8 | 5 | 5 | 6 | 17 | 22 |
| | 250 | 3 | 3 | 3 | 4 | 10 | 13 |
| | 400 | 4.7 | 2 | 2 | 2 | 6 | 8 |
| High-pressure sodium-vapour lamps parallel correction | 1000 | 10.3 | - | - | 1 | 3 | 3 |
| | 150 | 0.83 | 1 | 1 | 1 | 11 | 16 |
| | 250 | 1.5 | - | - | 1 | 6 | 10 |
| | 400 | 2.4 | - | - | - | 4 | 6 |
| Low-pressure sodium-vapour lamps uncorrected | 1000 | 6.3 | - | - | - | 2 | 3 |
| | 18 | 0.35 | 22 | 22 | 27 | 71 | 90 |
| | 35 | 1.5 | 7 | 7 | 9 | 23 | 30 |
| | 55 | 1.5 | 7 | 7 | 9 | 23 | 30 |
| | 90 | 2.4 | 4 | 4 | 5 | 14 | 19 |
| | 135 | 3.5 | 3 | 3 | 4 | 10 | 13 |
| Low-pressure sodium-vapour lamps parallel correction | 180 | 3.3 | 3 | 3 | 4 | 10 | 13 |
| | 18 | 0.35 | 6 | 6 | 7 | 44 | 66 |
| | 35 | 0.31 | 1 | 1 | 1 | 11 | 16 |
| | 55 | 0.42 | 1 | 1 | 1 | 11 | 16 |
| | 90 | 0.63 | 1 | 1 | 1 | 8 | 12 |
| | 135 | 0.94 | - | - | - | 4 | 7 |
| Low-pressure sodium-vapour lamps parallel correction | 180 | 1.16 | - | - | - | 5 | 8 |

EAN codes for VS

**VS120**

VS120-10UL 230V AC/DC: 8595188189880
 VS120-10UL 120V AC/DC: 8595188189897
 VS120-10UL 24V AC/DC: 8595188189903

VS120-01UL 230V AC/DC: 8595188189910
 VS120-01UL 120V AC/DC: 8595188189927
 VS120-01UL 24V AC/DC: 8595188189934

VS220

VS220-20UL 230V AC/DC: 8595188189828
 VS220-20UL 120V AC/DC: 8595188189835
 VS220-20UL 24V AC/DC: 8595188189842

VS220-11UL 230V AC/DC: 8595188189859
 VS220-11UL 120V AC/DC: 8595188189866
 VS220-11UL 24V AC/DC: 8595188189873

VS220-02UL 230V AC/DC: 8595188189941
 VS220-02UL 120V AC/DC: 8595188189958
 VS220-02UL 24V AC/DC: 8595188189965

VS325

VS325-30UL 230V AC/DC: 8595188190039
 VS325-30UL 120V AC/DC: 8595188190046
 VS325-30UL 24V AC/DC: 8595188190053

VS425

VS425-40UL 230V AC/DC: 8595188189972
 VS425-40UL 120V AC/DC: 8595188189989
 VS425-40UL 24V AC/DC: 8595188189996

VS425-31UL 230V AC/DC: 8595188190008
 VS425-31UL 120V AC/DC: 8595188190015
 VS425-31UL 24V AC/DC: 8595188190022

VS425-22UL 230V AC/DC: 8595188190060
 VS425-22UL 120V AC/DC: 8595188190077
 VS425-22UL 24V AC/DC: 8595188190084

VS425-04UL 230V AC/DC: 8595188190091
 VS425-04UL 120V AC/DC: 8595188190107
 VS425-04UL 24V AC/DC: 8595188190114

VS440

VS440-40UL 230V AC/DC: 8595188190121
 VS440-40UL 120V AC/DC: 8595188190138
 VS440-40UL 24V AC/DC: 8595188190145

VS440-31UL 230V AC/DC: 8595188190152
 VS440-31UL 120V AC/DC: 8595188190169
 VS440-31UL 24V AC/DC: 8595188190176

VS440-22UL 230V AC/DC: 8595188190213
 VS440-22UL 120V AC/DC: 8595188190220
 VS440-22UL 24V AC/DC: 8595188190237

VS440-04UL 230V AC/DC: 8595188190244
 VS440-04UL 120V AC/DC: 8595188190251
 VS440-04UL 24V AC/DC: 8595188190268

VS363

VS363-30UL 230V AC/DC: 8595188190336
 VS363-30UL 120V AC/DC: 8595188190343
 VS363-30UL 24V AC/DC: 8595188190350

VS463

VS463-40UL 230V AC/DC: 8595188190275
 VS463-40UL 120V AC/DC: 8595188190282
 VS463-40UL 24V AC/DC: 8595188190299

VS463-31UL 230V AC/DC: 8595188190305
 VS463-31UL 120V AC/DC: 8595188190312
 VS463-31UL 24V AC/DC: 8595188190329

VS463-22UL 230V AC/DC: 8595188190367
 VS463-22UL 120V AC/DC: 8595188190374
 VS463-22UL 24V AC/DC: 8595188190381

VS340

VS340-30UL 230V AC/DC: 8595188190183
 VS340-30UL 120V AC/DC: 8595188190190
 VS340-30UL 24V AC/DC: 8595188190206

EAN codes for VSK and covers

VSK-11: 8595188121613
 VSK-20: 8595188121606

Explore our best-selling non-UL products, including high-quality relays and other essential components.

Trusted by professionals across the U.S. market and providing reliable performance and exceptional value for various applications.



CRM-91HE

(10 functions)
Multifunction Timer Relay
with External Potentiometer



- Control by external control unit - potentiometer (can be placed/mounted for example on switch board doors or in panel).



CRM-2HE

(2 functions)
Asymmetric Flasher with
External Potentiometers



- Control by external control unit - potentiometer (can be placed/mounted for example on switch board doors or in panel).



CRM-9S

(10 functions)
Multifunction
Timer Relay



- Multifunction time relay for universal use in automation, control, and regulation or in-house installations.



HRN-100

(4-wire connection)
Multifunction Voltage
Monitoring Relay in 3P with
LCD Display



- Multifunction and in many ways universal monitoring relay which protects devices and equipment connected to a 3-phase network.



HRH-5
(2 functions)
Asymmetric Flasher with External Potentiometers



- Control by external control unit - potentiometer (can be placed/ mounted for example on switch board doors or in panel).



MR-41
MR-42
Memory Relays



- Relays MR-41, MR-42 memorize its last state even after supply failure. During the failure relay will turn off and after re-energizing will automatically turns on.



TER-7
(10 functions)
Temperature Monitoring Thermostat



- It monitors motor coil temperature.
- Fixed levels of switching.



TER-9
(10 functions)
Digital Thermostat



- Digital thermostat with 6 functions and built-in time switch clock with day, week and year program. You can also limit temperature functions and courses this way in real time.



SJR-2
(10 functions)
ON DELAY Time Relay



- For gradual switching of high power, prevents current strokes in the main.

**HRN-31**

(replaces HRN-33, -63)

1P AC/DC Multifunction Voltage Monitoring RelayDescribed Function
Overvoltage Monitoring**Manufacturing****CNC Machining Center**

- Prevents CNC machine control unit damage by monitoring for states above the voltage limit.
- Maintains operational precision, reduces downtime, and repair costs by ensuring voltage is within safe limits for the equipment.

**HRN-32/2**

(replaces HRN-35)

1P AC/DC Multifunction Voltage Monitoring RelayDescribed Function
Dual Overvoltage Monitoring**Data Centers****Dual Power Supply Units for Servers**

- Prevents CNC machine control unit damage by monitoring for states above the voltage limit.
- Maintains operational precision, reduces downtime, and repair costs by ensuring voltage is within safe limits for the equipment.

**HRN-36**

(replaces HRN-34, -64)

1P DC Multifunction Voltage Monitoring RelayDescribed Function
Overvoltage + Latch**Public Transportation****Ticket Vending Machines**

- Prevents vending machine failure by monitoring for states above the voltage limit.
- Maintains service reliability, reduces downtime, and repair costs by ensuring voltage is within operational safety limits.

**HRN-39**

(replaces HRN-37, -67)

1P AC/DC Multifunction Voltage Monitoring RelayDescribed Function
Undervoltage Monitoring**Healthcare****Medical Laboratory Refrigerators**

- Prevents damage to sensitive samples by monitoring for states below the voltage limit.
- Ensures critical temperature control is maintained, reduces risk of sample spoilage, and supports compliance with healthcare standards.

**HRN3-81****3P AC Undervoltage and Phase Monitoring Relay**Described Function
Phase Failure Monitoring**Utilities****Electrical Substation Transformer**

- Detects phase failure in transformers to prevent damage and maintain power distribution efficiency.
- Ensures consistent electrical supply, reducing the risk of power outages and associated costs by maintaining grid reliability.



SHT-13 / SHT-13/2
Multifunction Digital Time Switch With Wi-Fi Connection

Described Function
 Smart Control and Monitoring

Conference Rooms
Automated Light Adjustment

- Adjusts lighting based on schedule meetings and ambient light, ensuring optimal lighting conditions.
- Wi-Fi connectivity allows for remote adjustments and monitoring, providing flexibility and ease of use.



PRI-34
1P AC Multifunction Current Monitoring Relay

Described Function
 Window

Renewable Energy
Solar Panel Inverters

- Prevents inverter damage by monitoring for current outside operational ranges.
- Maintains system efficiency, reduces downtime, and repair costs by ensuring current is within safe limits for the equipment.



HRN3-70
3P AC Overvoltage and Phase Monitoring Relay

Described Function
 Overcurrent with Hysteresis

Construction
Electric Floor Heating

- Prevents floor heating system overload by monitoring for current beyond safe limits.
- Enhances safety and efficiency, using hysteresis to minimize unnecessary switching, maintaining a consistent and optimal heating environment.



PMR1-31
1P AC/DC Multifunction Voltage Monitoring Relay

Described Function
 Window + Latch

Industrial Automation
Automated Assembly Line Equipment

- Monitors voltage levels to ensure automated equipment operates within safe electrical conditions.
- The latch function locks the system in a safe state, requiring a manual restart, preventing damage due to persistent unstable conditions.



PMR1-36/2
1P DC Multifunction Voltage Monitoring Relay

Described Function
 Dual Window Monitoring

Water Treatment
Pump Control Systems in Water Distribution

- Ensures pumps operate within precise voltage windows, critical for water flow consistency.
- Dual circuits allow monitoring of two systems, improving reliability and efficiency in water distribution.

**CRM-161**

(10 functions)

**Multifunction
Time Relay**Described Function
On Delay**Automotive Industry****Assembly line**

- Coordination of timing between individual production line stations:
- When one station completes its part of the work (e.g., engine assembly), the timing relay triggers the next station (e.g., body assembly) after a set delay.

**CRM-183J ZR****Singlefunction
Time Relay**

On Delay

Water Treatment and Waste Management**Pumps in a water treatment plant**

- Delayed activation of individual pumps:
- When starting multiple pumps (e.g., during the transfer of waste to the biological treatment tanks), the relay ensures that the pumps are activated one after another, with a defined delay.

**CRM-2H****Singlefunction
Time Relay**

Asymmetric Cycler

HVAC Industry**Building ventilation system**

- Warehouse cyclic ventilation:
- In rooms that need to be regularly ventilated (e.g., a storage room), the relay can be programmed to regularly turn the ventilation system on and off, allowing for effective and precise control of ventilation cycles.

**CRM-82TO**

(2 functions)

**Multifunction
Time Relay**Described Function
Off Delay Without
Supply Voltage**Security Industry****Emergency lighting**

- Delayed shutdown of emergency lighting after the main power source is restored:
- It allows the emergency lighting to be powered by a backup source for up to 10 minutes after the main power source is restored, avoiding a complete blackout in case of a repeated power outage.

**CRM-91H**

(10 functions)

**Multifunction
Time Relay**Described Function
Impulse Generator**Textile Industry****Fabric feeding machine**

- Feeding machine timing:
- The relay generates pulses at a specific interval to ensure precise timing and control of the fabric feeding machine. It guarantees its efficient and reliable operation with precisely set parameters.



CRM-93H

(10 functions)

Multifunction Time Relay

Described Function
Memory (Impulse) Relay

Elevator Manufacturing

Passenger elevator

- Floor buttons and consequent elevator movement:
- After pressing a floor button, the relay activates the corresponding circuit and keeps it active even after the impulse ended, keeping the elevator in motion, until a second pulse is received, this time to stop the elevator.



HRN-56

Voltage Monitoring Relay

Food Industry

Motor in an industrial mixer

- Stopping the motor in case of a phase failure:
- In case of a phase failure, the relay stops the mixer motor to prevent any damage that may occur due to its improper rotation.



PRI-51

Current Monitoring Relay

Electronics Manufacturing

Assembly line

- Overcurrent monitoring in component motors:
- In case of overcurrent in the motor of an assembly line component, the relay will turn off this motor to prevent it from overloading or jamming.



VS116U

Power Relay

Mining industry

Mining excavator

- Control of mining excavator components:
- The components of an excavator are controlled by massive motors, operating at currents too high to be controlled directly. The relay splits the circuit into a control part and a power part. The control part operates at a low current, which can be handled by the control panel inside the driver's cabin.



VS308U

Power Relay

Construction

Construction crane

- Control of mining excavator components:
- The components of an excavator are controlled by massive motors, operating at currents too high to be controlled directly. The relay splits the circuit into a control part and a power part. The control part operates at a low current, which can be handled by the control panel inside the driver's cabin.

Agriculture, Forestry, Farming - Dryers, Grain Processing Machines

Time Relays

- Starting equipment in sequence (inrush current prevention)

Auxiliary Relays

- Electrically separating circuits

Monitoring Relays

- Detecting and preventing overload



Buildings, Complexes, Stadiums, Amusement Parks - Gate & Garage Door Panels

Time Relays

- Delayed start / extended operation

Auxiliary Relays

- Switching single phase load

Monitoring Relays

- Indicating current flow



Car Washing Stations - Compressors

Time Relays

- Cyclic control

Auxiliary Relays

- Utilizing a range of AC/DC supply voltages

Monitoring Relays

- Safe stop / off in case power loss



Cement / Concrete Plants - Grinder / Crusher Motor Auxiliary Heaters / Cooling Fans

Time Relays

- Starting and stopping loads at a specific time of day

Auxiliary Relays

- Electrically separating circuits

Monitoring Relays

- Indicating overcurrent / overvoltage



EV Charging (Station Manufacturing & Servicing) - Fast Charging Station Auxiliary Circuits

Time Relays

- Timing signal lamps, horns

Auxiliary Relays

- Switching single phase load

Monitoring Relays

- Preventing damage in case of overcurrent / overvoltage



Food & Beverage (Production & Processing) – Conveyor Systems, Automated Lines, Injectors, Fillers

Time Relays

- Cyclic light & heat control

Auxiliary Relays

- Utilizing a range of AC/DC supply voltages

Monitoring Relays

- Controlling switching between power sources



Heavy Industry, Metals – High Power Motor Auxiliary Heaters / Cooling Fans

Time Relays

- Starting equipment in sequence (inrush current prevention)

Auxiliary Relays

- Electrically separating circuits

Monitoring Relays

- Detecting and preventing overload



Lighting - High Power Street Lamps

Time Relays

- Delayed start / extended operation

Auxiliary Relays

- Switching single phase load

Monitoring Relays

- Indicating current flow



Mining Sites – Kiln Auxiliary Drives & Heaters

Time Relays

- Cyclic control

Auxiliary Relays

- Electrically separating circuits

Monitoring Relays

- Safe stop / off in case power loss



Oil & gas – Pump Motor Auxiliary Heaters

Time Relays

- Starting and stopping loads at a specific time of day

Auxiliary Relays

- Switching single phase load

Monitoring Relays

- Indicating overcurrent / overvoltage



Plastic Produce – Single Phase DOL Starters

Time Relays

- Cyclic control

Auxiliary Relays

- Utilizing a range of AC/DC supply voltages

Monitoring Relays

- Preventing damage in case of overcurrent / overvoltage



Pulp & paper – DC Drive Field Circuits

Time Relays

- Delayed start / extended operation

Auxiliary Relays

- Electrically separating circuits

Monitoring Relays

- Controlling switching between power sources



Pump stations & Water Treatment Plants – Single Phase Motors & Actuators

Time Relays

- Starting and stopping loads at a specific time of day

Auxiliary Relays

- Switching single phase load

Monitoring Relays

- Preventing damage in case of overcurrent / overvoltage



Renewable Energy (Solar, Wind) – Battery Storage Units

Time Relays

- Timing signal lamps, horns

Auxiliary Relays

- Utilizing a range of AC/DC supply voltages

Monitoring Relays

- Indicating current flow



Warehouse & Other Logistics Operations – Automated Shelving Systems

Time Relays

- Cyclic light & heat control

Auxiliary Relays

- Electrically separating circuits

Monitoring Relays

- Safe stop / off in case power loss



Problematic choice of suitable relay contact for a particular load switched with a product is described below. Mostly we experience problems with incorrect choice of load (meaning incorrect relay for a particular load) which results in permanent switching of contact (sealing) or damage on relay contact – which then results in malfunction.
 What load can you use? Detailed types of load according to standard EN 60947 are described in charts below – categories of use.

| Category of use | Typical use | EN |
|-----------------|-------------|----|
|-----------------|-------------|----|

AC current, $\cos\phi = P/S (-)$

| | | |
|--------|---|-----------|
| AC-1 | Non-inductive or slightly inductive load, resistance furnace Includes all appliances supplied by AC current with power factor ($\cos \phi$) ≥ 0.95 Examples of usage: resistance furnace, industrial loads | 60947-4 |
| AC-2 | Motors with slip-ring armature, switching off | 60947 |
| AC-3 | Motors with short-circuit armature, motor switching when in operation This category applies to switching off motors with short-circuit armature while in operation. While switching, contactor switches current which is 5 up to 7 times rated current of motor. | 60947-4 |
| AC-4 | Electro-motors with short-circuit armature: start up, braking by backset, changeover | 60947 |
| AC-5a | Switching of electrical gas-filled lights, fluorescent lights | 60947-4 |
| AC-5b | El. bulb switching Enables low contact loading due to resistance of cold fiber is many times smaller than the one of hot fiber. | 60947-4 |
| AC-6a | Switching of transformers | 60947-4 |
| AC-6b | Switching of capacitors | 60947-4 |
| AC-7a | Switching low inductive loads of home appliances and similar applications | 60947 |
| AC-7b | Load of motors for home appliances | 60947 |
| AC-8a | Switching of hermetically sealed motors of cooling compressors with manual reset switches against overload Hermetically sealed cooling compressors have to be placed in one box without external shaft or shaft padding and motor must operate with cooling liquid | 60947 |
| AC-8b | Switching of hermetically sealed motors of cooling compressors with manual reset switches against overload Hermetically sealed cooling compressors have to be placed in one box without external shaft or shaft padding and motor must operate with cooling liquid | 60947 |
| AC-12 | Switching of semiconductor loads with separation transformers | 60947-5 |
| AC-13 | Switching of semiconductor loads with separation transformers | 60947-5-1 |
| AC-14 | Switching of low electro-magnetic loads (max.72 VA) | 60947-5-1 |
| AC-15 | Management of alternating electro-magnetic loads This category applies to switching inductive loads with input for closed electro-magnetic circuit higher than 72 VA Use: switching coils of contactors | 60947-5 |
| AC-20 | Connecting and disconnecting in unloaded states | 60947-3 |
| AC-21 | Switching resistive loads, including low loading | 60947-3 |
| AC-22 | Switching of mixed resistive and inductive loads, including low overloading | 60947-3 |
| AC-23 | Switching of motor loads or other high inductive loads | 60947-3 |
| AC-53a | Switching of motors with short-circuit armature with semiconductor contactors | 60947 |

Note: Category AC 15 replaces formerly used category AC 11

DC current, $t = L/R (s)$

| | | |
|-----------|--|-----------|
| DC-1 | Non-inductive or low inductive load, resistive furnaces | 60947-4 |
| DC-3 | Shunt motors: start-up, braking by backset, reversion, resistive braking | 60947-4-1 |
| DC-5 | Series motor: start-up, braking by backset, reversion, resistive braking | 60947-4-1 |
| DC-6 | Non-inductive or low inductive loads, resistive furnaces – el. bulbs | 60947-4-1 |
| DC-12 | Management of resistive loads and fixed loads with insulation by opto-electric element | 60947-5-1 |
| DC-13 | Switching of electromagnets | 60947-5-1 |
| DC-14 | Switching of electromagnetic loads in circuits with limiting resistor | 60947-5-1 |
| DC-20a(b) | Switching and breaking without load(a: frequent switching ,b: occasional switching) | 60947-3 |
| DC-21a(b) | Switching ohmic loads including limiting overloading (a: frequent switching ,b: occasional switching) | 60947-3 |
| DC-22a(b) | Switching of compound ohmic and inductive loads including limited overloads (e.g. shunt motors) (a: frequent switching, b: random switching) | 60947-3 |
| DC-23 | Switching of highly inductive loads (e.g. series motors) | 60947-3 |

How can you distinguish for which load is our product (relay) designated?

Our company record this information on a products and also in our catalog, instruction manual and other promotional and technical material (website etc.).



















It is important to realize that it is not always possible to point out load because of lack of information about the device (user cannot measure cos) or it is not possible because of inconstancy of parameters of switched device. Manufacturer of relays records always guaranteed parameters in ideal conditions which are done by a norm (temperature, pressure, humidity, etc.) and reality can be in a lot of cases different. Category of use (classification) of a particular relay is done by material of output contacts.

Basic types of materials which are used for production of contacts for high-performance relay are:



















- AgCd – suitable for switching ohmic loads. Before of harmfulness of Cd, this type of contact is remitted.
- AgNi – designated for switching resistive loads, good quality switching and conducting (contact doesn't oxidate) small currents/voltages, it is not designated for surge currents and loads with inductive component.
- AgSn or AgSnO₂ – suitable for switching loads with inductive component, not suitable for switching small currents/voltages, it is more resistive to surge currents, suitable for DC voltage switching, less suitable for switching loads of ohmic type.
- Wf (wolfram)-special contact designated for switching surge currents with inductive component.
- with gold (AgNi/Au)- Used for "improving" contacts for low currents/ voltages , prevents oxidation.

Product loadability



















CRM-2H; CRM-2T; CRM-181J; CRM-91H; CRM-111H; CRM-183J / CRM-93H / CRM-113H (1. kontakt); CRM-121H; CRM-131H; HRN-31; HRN-31/2; HRN-32/2; HRN-36; HRN-39; HRN3-70; HRN3-80; HRN3-81; PMR1-31; PMR1-31/2; PMR1-36; PMR1-36/2; PMR1-39; PMR1-39/2; PMR3-70; PRI-34; PTRM-216K; PTRM-216T; PTRM-216KP; PTRM-216TP; PTRM-216K; PTRM-216T;

| | | | | | | | | | |
|----------------------------------|---|---|---|---|---|--|---|---|---|
| type of load |  cos φ ≥ 0.95 |  |  |  |  |  HAL.230V |  |  |  |
| Material of contact AgNi, 16A | AC1 250V/16A | AC2 250V/5A | AC3 250V/3A | AC5a uncompensated 230V/3A (690VA) | AC5a compensated x | AC5b 800W | AC6a x | AC7b 250V/3A | AC12 250V/10A |
| type of load |  |  |  |  |  |  |  |  |  |
| Material of contact AgNi, 16A | AC13 250V/6A | AC14 250V/6A | AC15 250V/6A | DC1 24V/16A | DC3 24V/6A | DC5 24V/4A | DC12 24V/16A | DC13 24V/2A | DC14 24V/2A |

VS116U

| | | | | | | | | | |
|---|---|---|---|---|---|--|---|---|---|
| type of load |  cos φ ≥ 0.95 |  |  |  |  |  HAL.230V |  |  |  |
| Material of contact AgSnO ₂ , 16A | AC1 250V/16A | AC2 250V/5A | AC3 250V/3A | AC5a uncompensated 230V/3A (690VA) | AC5a compensated 230V/3A (690VA) till max output C=14UF | AC5b 1 000W | AC6a x | AC7b 250V/3A | AC12 x |
| type of load |  |  |  |  |  |  |  |  |  |
| Material of contact AgSnO ₂ , 16A | AC13 x | AC14 250V/6A | AC15 250V/6A | DC1 24V/16A | DC3 24V/3A | DC5 24V/2A | DC12 24V/16A | DC13 24V/2A | DC14 x |

CRM-82TO; CRM-183J / CRM-93H / CRM-113H (2. + 3. kontakt); VS308U; CRM-161; HRN-56; PRI-32; PRI-51;

| | | | | | | | | | |
|---------------------------------|---|---|---|---|---|--|---|---|---|
| type of load |  cos φ ≥ 0.95 |  |  |  |  |  HAL.230V |  |  |  |
| Material of contact AgNi, 8A | AC1 250V/8A | AC2 250V/3A | AC3 250V/2A | AC5a uncompensated 230V/1.5A (345VA) | AC5a compensated x | AC5b 300W | AC6a x | AC7b 250V/1A | AC12 250V/1A |
| type of load |  |  |  |  |  |  |  |  |  |
| Material of contact AgNi, 8A | AC13 x | AC14 250V/3A | AC15 250V/3A | DC1 24V/8A | DC3 24V/3A | DC5 24V/2A | DC12 24V/8A | DC13 24V/2A | DC14 x |

VS120; VS220

| | | | | | | | | | | | | | |
|---------------|--------------------------|------|-----------------------------------|-----------------|-----------------|-----------------|-----------------|--------------------|--------------------|--------------------|---------------------|---------------------|-----------------------------|
| type of load | AC-1, AC-7a, AC-21 | AC-2 | AC-3, AC-3e, AC-7b, AC23 | AC-5a (230V) | AC-5b (230V) | AC-6a (230V) | AC-15 (230V) | DC-1 (24V, 48V) | DC-3 (24V, 48V) | DC-5 (24V, 48V) | DC-13 (24V, 48V) | LED | AC-6b, AC-7c (230V) |
| rated current | 20A | 12A | NO9A NC6A | 8,8A | 8,8A | 4A | 6A | 20A, 15A | 10A, 5A | 10A, 4A | 6A | 2,4A per contact | switching capacity 30 uF |

VS425

| | | | | | | | | | | | | | |
|---------------|--------------------------|------|-----------------------------------|-----------------|-----------------|-----------------|-----------------|--------------------|--------------------|--------------------|---------------------|---------------------|-----------------------------|
| type of load | AC-1, AC-7a, AC-21 | AC-2 | AC-3, AC-3e, AC-7b, AC23 | AC-5a (230V) | AC-5b (230V) | AC-6a (230V) | AC-15 (230V) | DC-1 (24V, 48V) | DC-3 (24V, 48V) | DC-5 (24V, 48V) | DC-13 (24V, 48V) | LED | AC-6b, AC-7c (230V) |
| rated current | 25A | 14A | 8,5A | 11,2A | 8,8A | 2,8A | 6A | 25A, 20A | 15A, 8A | 15A, 5A | 6A | 3,8A per contact | switching capacity 36 uF |

VS440

| | | | | | | | | | | | | | |
|---------------|--------------------------|------|-----------------------------------|-----------------|-----------------|-----------------|-----------------|--------------------|--------------------|--------------------|---------------------|--------------------|------------------------------|
| type of load | AC-1, AC-7a, AC-21 | AC-2 | AC-3, AC-3e, AC-7b, AC23 | AC-5a (230V) | AC-5b (230V) | AC-6a (230V) | AC-15 (230V) | DC-1 (24V, 48V) | DC-3 (24V, 48V) | DC-5 (24V, 48V) | DC-13 (24V, 48V) | LED | AC-6b, AC-7c (230V) |
| rated current | 40A | 25A | 22A | 20A | 17,6A | 10,8A | 6A | 40A, 25A | 22A, 10A | 20A, 8A | 6A, 4A | 11A per contact | switching capacity 220 uF |

VS463

| | | | | | | | | | | | | | |
|---------------|--------------------------|------|-----------------------------------|-----------------|-----------------|-----------------|-----------------|--------------------|--------------------|--------------------|---------------------|--------------------|------------------------------|
| type of load | AC-1, AC-7a, AC-21 | AC-2 | AC-3, AC-3e, AC-7b, AC23 | AC-5a (230V) | AC-5b (230V) | AC-6a (230V) | AC-15 (230V) | DC-1 (24V, 48V) | DC-3 (24V, 48V) | DC-5 (24V, 48V) | DC-13 (24V, 48V) | LED | AC-6b, AC-7c (230V) |
| rated current | 63A | 32A | 30A | 32A | 22A | 17,2A | 6A | 63A, 26A | 25A, 11A | 25A, 10A | 6A, 4A | 18A per contact | switching capacity 330 uF |

Packing of 1-MODULE relay - 1 pc



Packing of 1-MODULE relay - 10 pcs



Packing of 1-MODULE relay with accessories



+



or



Packing of 2-MODULE relay - 1 pc



Packing of 3-MODULE relay - 1 pc



1-MODULE

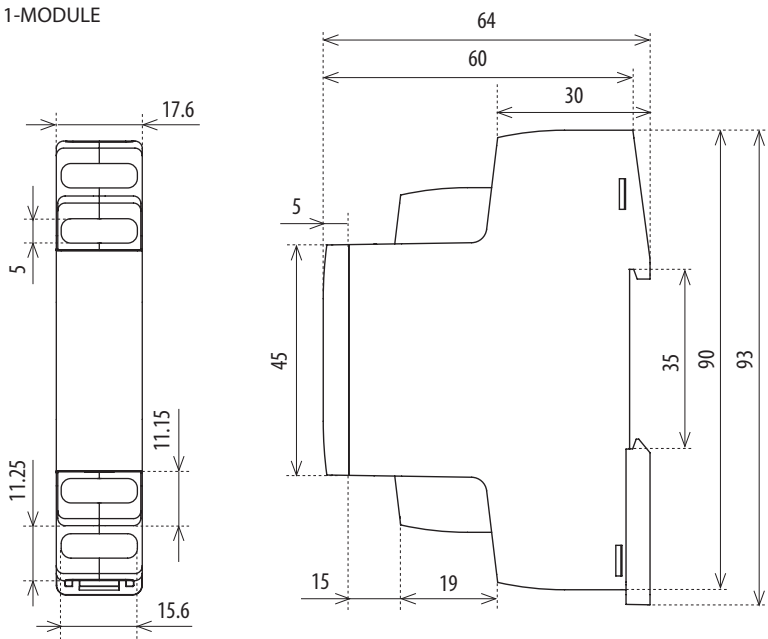

Front panels for 1-MODULE, examples of use:

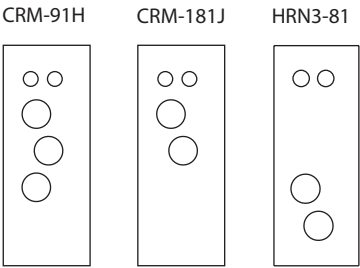

3-MODULE

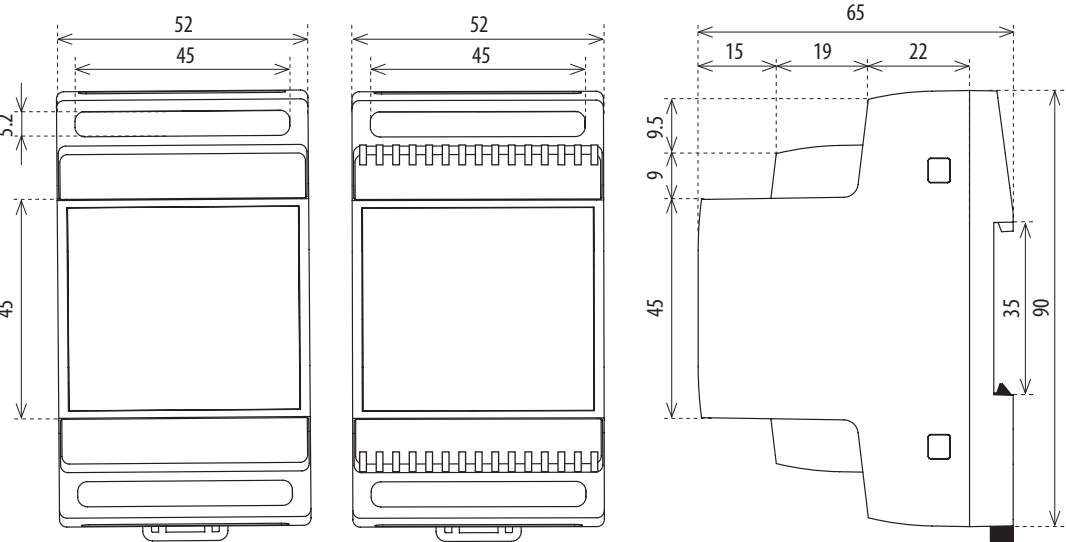

2-MODULE

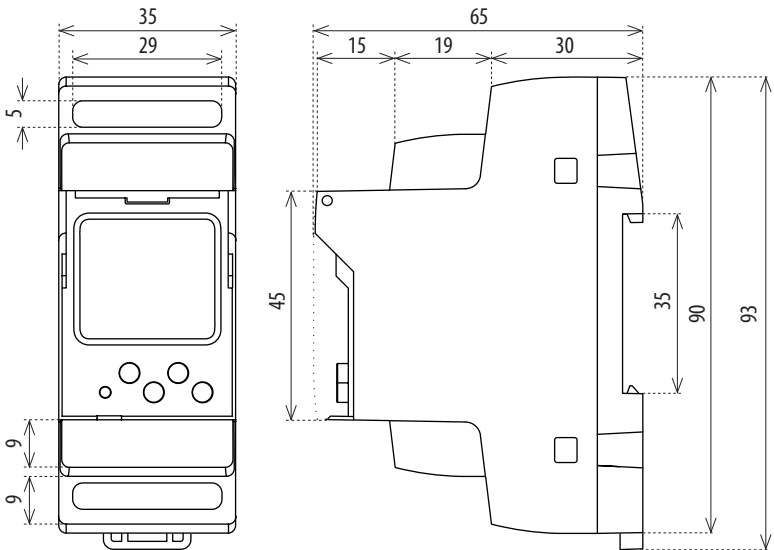

6-MODULE

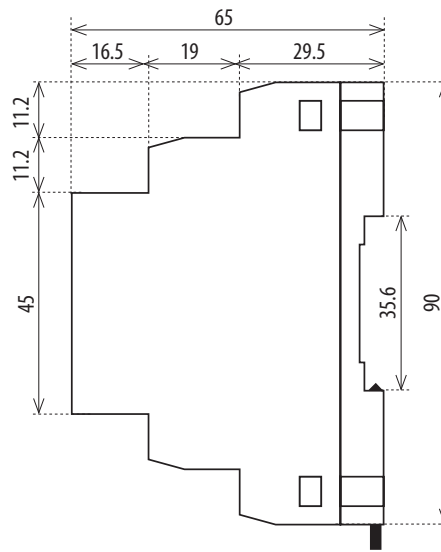
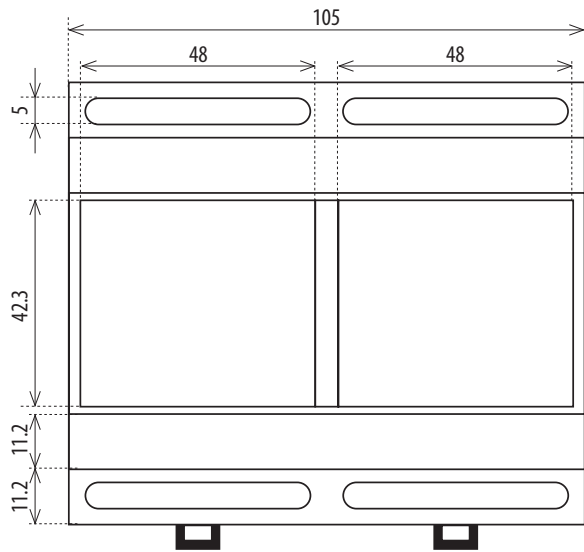

Front panels for 6-MODULE, examples of use:

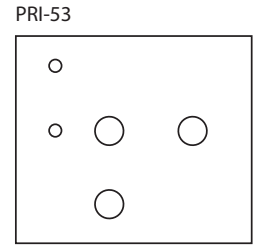

PMR3-70

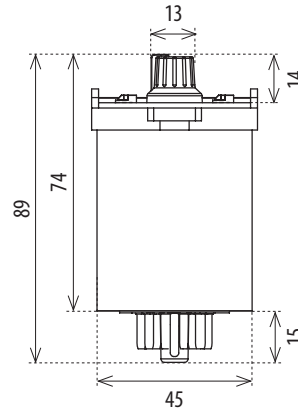
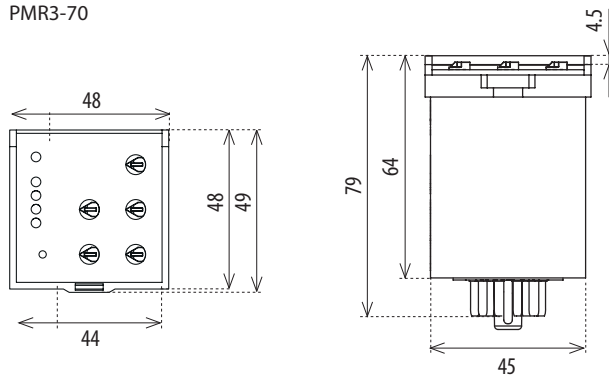

front panels PLUG-IN, examples of use:

PTRx-216T

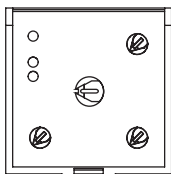

PTRx-216K

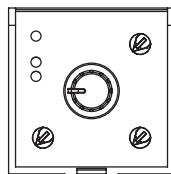

PMR1-3x

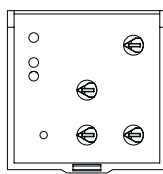

VS120
VS220

VS425

VS440
VS463

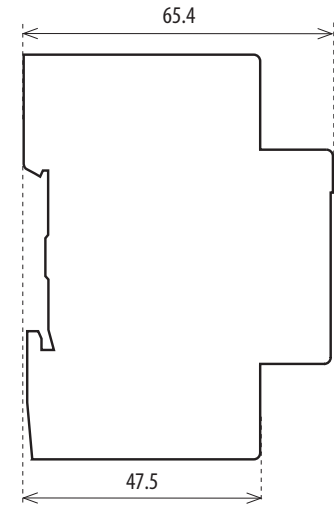
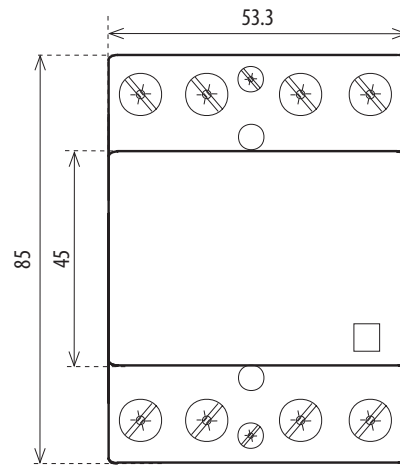
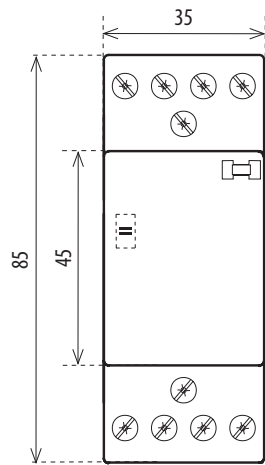
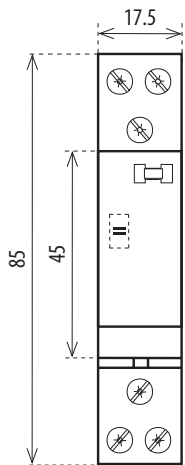

PS1M-15/12V
PS1M-15/24V

PS2M-24/12V
PS2M-30/24V

PS3M-54/12V
PS3M-60/24V

PS4M-85/12V
PS4M-92/24V

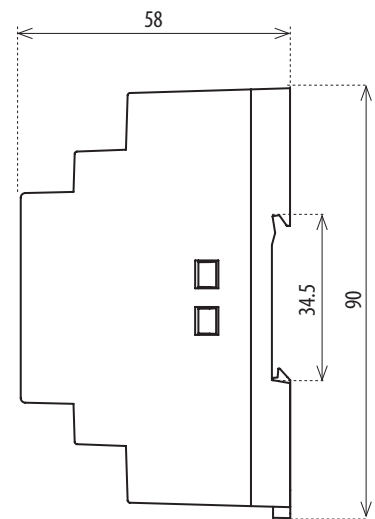
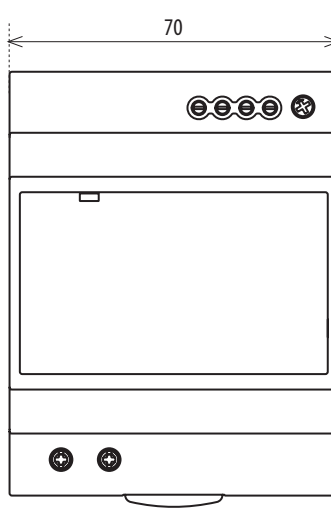
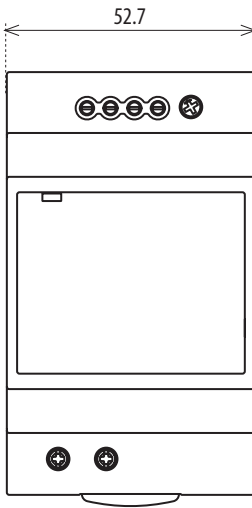
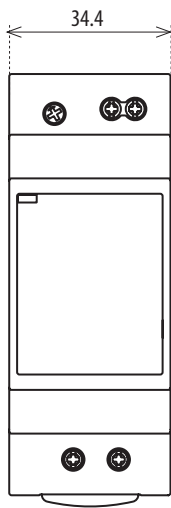

Multifunction time relay CRM-91H, CRM-93H

- for electric appliances, where is necessary to change the exact timing - controlling of the illumination, heating, motors, machines, ventilators, contactors

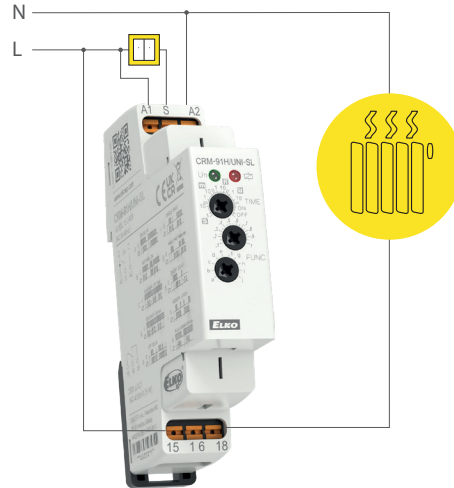
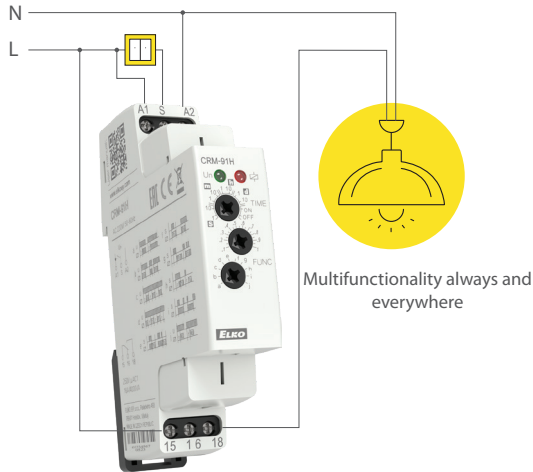

Time relay PLUG-IN type PTRM-216TP

- serves to control light signalization, heating, motor and fan control etc.



Delay OFF without supply voltage CRM-82TO

- delayed back-up switch off at current failure (emergency illumination, emergency respirator)

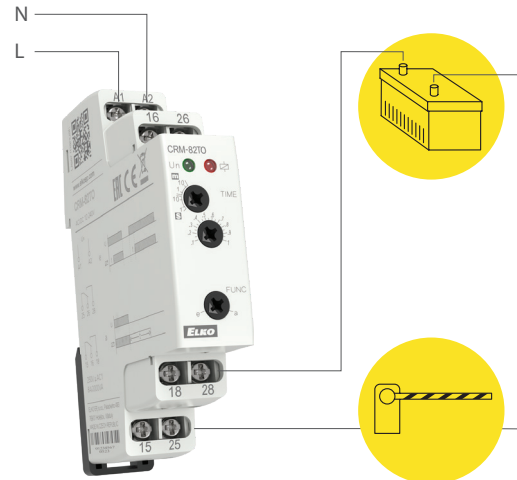

Asymmetric flasher CRM-2H

- regular rooms ventilation, cyclic humidity exhaustion, illumination controlling, circulation pump, flash, warning appliances, regular pump down, regular irrigation via electromagnetic valve



Singlefunction time relay CRM-181J

- time switch, using for run down the pump after switch off the heating, switching of ventilators

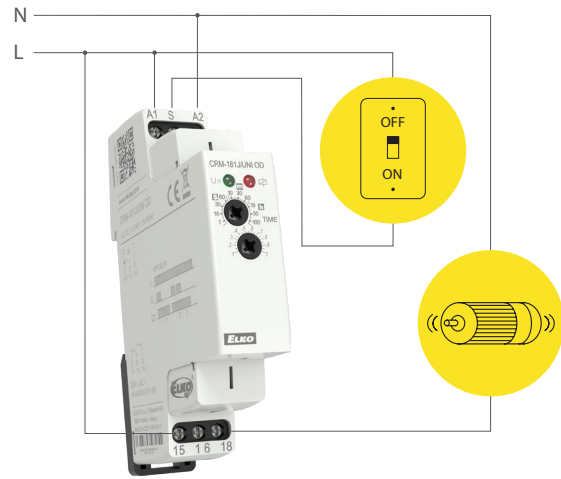

Modular contactor VS120, VS220, VS425

- to switch circuits for supply and control heating, lights, air-conditioning and other el. devices.

Switches loads AC-1, AC-3, AC-7a, AC-7b, AC-15.

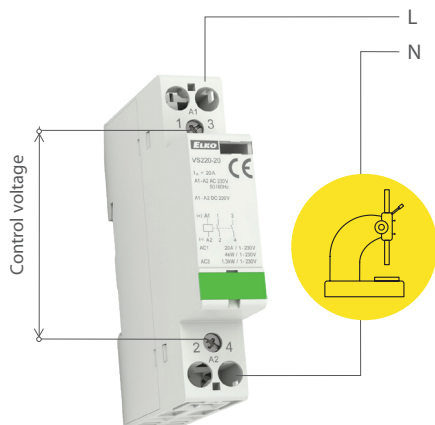

Voltage monitoring relay HRN-32/2

- start of back-up supply in case of failure

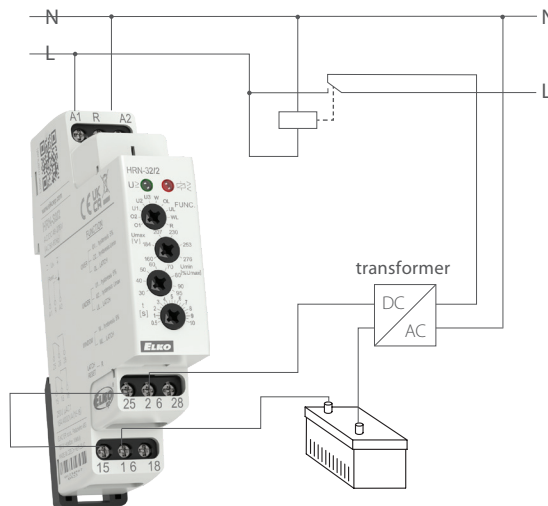

Monitoring voltage relay HRN-31 (HRN-31/2)

- monitoring of mains voltage for appliances inclinable to supply tolerance

Monitoring voltage relay HRN-31 (HRN-31/2)

- protection of appliances against under-/overvoltage

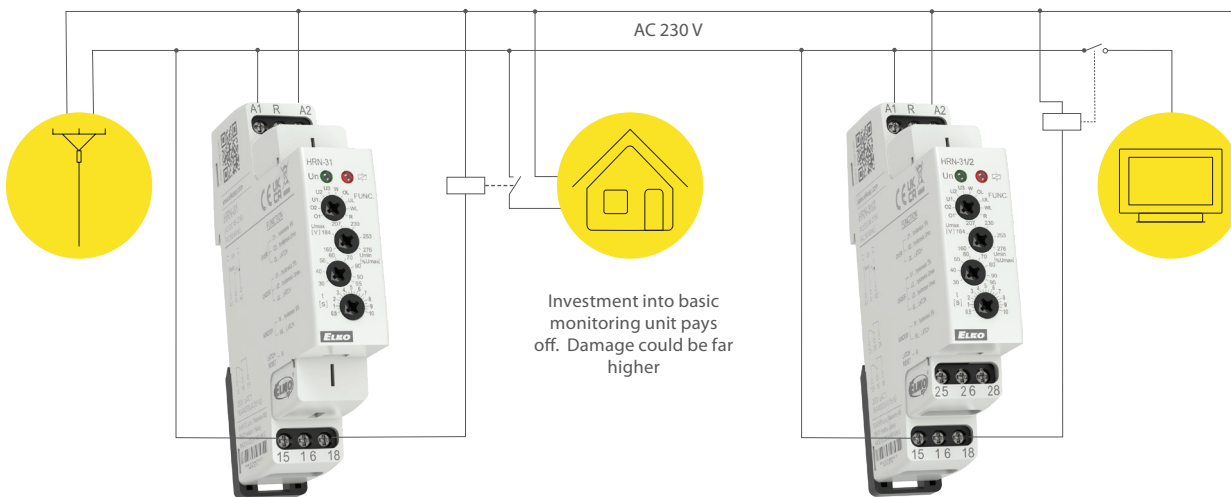

Monitoring voltage relay HRN-36

- load disconnected when voltage declines or battery is discharged

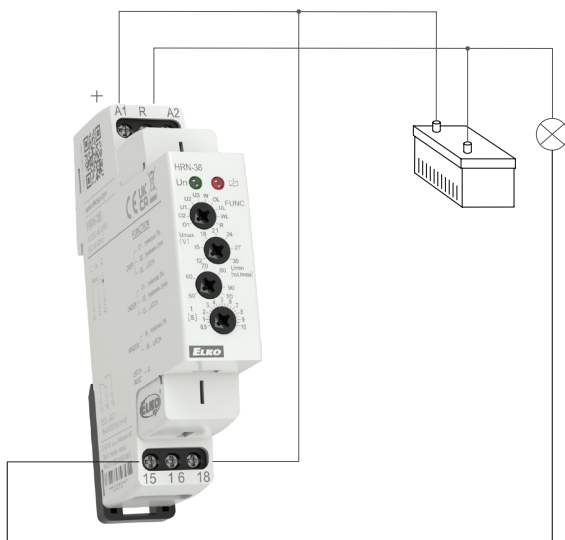

Modular contactors VS440, VS463

- to switch supply and control circuits for heating, air-conditioning and other el. devices, switching 3-phase motors
- Switches loads A-1, AC-3, AC-3, AC-7a, AC-7b, and AC-15

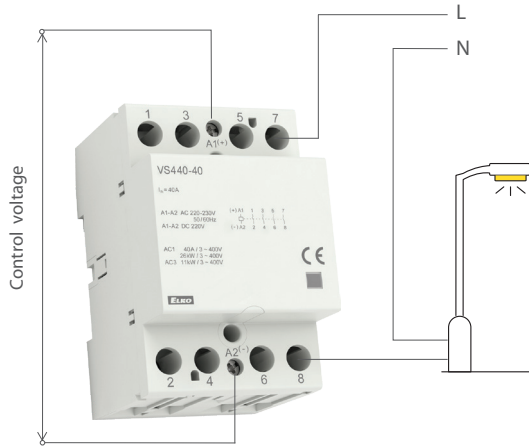

Power relays VS

- switching of higher load than is capacity of switched unit = repeater
- assistant light controlling, signalling, boilers, ...



Monitoring current relay PRI-51, PRI-32

- current-limiting relay (on one branch two appliances, which never work together), controlling systems, motors, heating, current indication, controlling of 1-phase motor run down, during the installation of main housing switchboard could be controlled via eye, if the cooker is not switched
- in connection with current transformers, it is possible to extend current ranges up to 600A, which makes more things possible

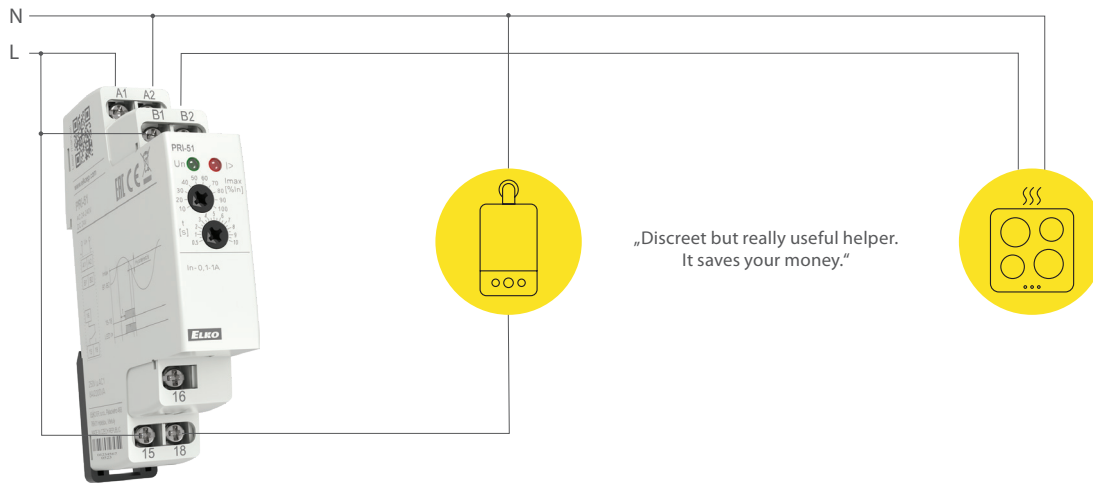

More Than Just Resellers

We innovate, develop and manufacture out products in-house



30 Years

On the Market



16 Years

ISO Certification

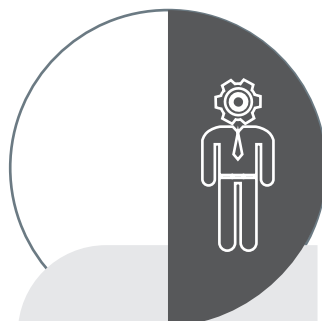

40

Developers



400

Employees



21 500 sq ft

Manufacturing
Space



200

Proprietary Plastic
Mods

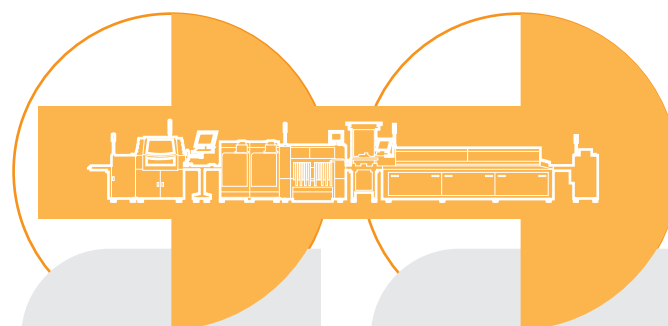

3

SMD Lines

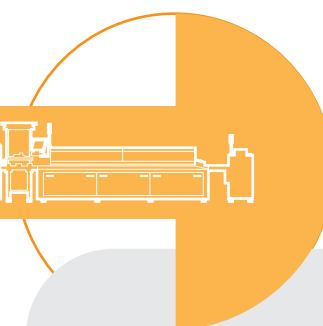

1 Mil.

Components
per Day

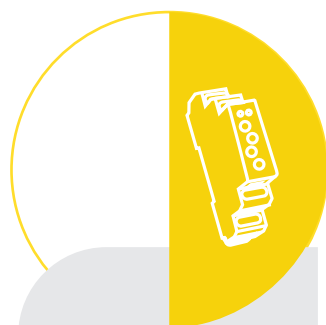

600 000

Products
per Year

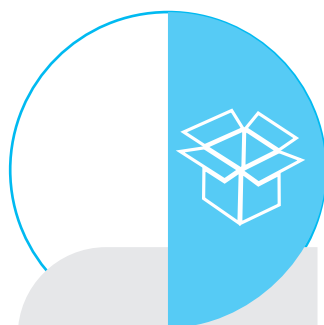

21 500 sq ft

Finalization
and Dispatch



2 000

Warehousing
Spaces



3

Printing Lasers



R&D overall view



Manufacturing hall



Testing lab



Finalization and dispatch



Jan Pacovsky

Managing member, CEO

Cell: +1(608)746-1332

Email: pacovsky@elkoep.na

www.elkoepna.com

Headquarters | 1150 NW 72nd Ave, Tower I, Suite 455 #9226 | Miami, FL 33126 |

phone: +1(608)746-1332 | pacovsky@elkoepna.com | www.elkoepna.com

Central Warehouse | 7200 Intermodal Dr, Louisville, KY 40258

