

CRM-91H, CRM-92H, CRM-93H | Multifunction time relays

Time relay - MULTIFUNCTION



EAN code
 CRM-91H/230V: 8595188112444
 CRM-91H/UNI: 8595188112420
 CRM-92H/UNI: 8595188176897
 CRM-93H/230V: 8595188112789
 CRM-93H/UNI: 8595188112468

- Multifunction time relay for universal use in automation, control and regulation or in house installations.
- Comfortable and well-arranged function and time-range setting by rotary switches.
- Multifunction red LED flashes or shines depending on the operating status.

Technical parameters	CRM-91H	CRM-92H	CRM-93H
Power supply			
Supply terminals:	A1 - A2		
Voltage range:	AC/DC 12 - 240 V (AC 50-60 Hz)		
Power input (max.):	2 VA/1.5 W	2.5 VA/1.5 W	2.5 VA/1.5 W
Voltage range:	AC 230 V (50/60 Hz)		
Power input (max.):	3VA/1.4W	-	4VA/2W
Supply voltage tolerance:	-15 %; +10 %		
Supply indication:	green LED		
Time circuit			
Number of functions:	10		
Time ranges:	0.1 s - 10 days		
Time setting:	rotary switch and potentiometer		
Time deviation:	5 % - mechanical setting		
Repeat accuracy:	0.2 % - set value stability		
Temperature coefficient:	0.01 %/°C, at = 20 °C (0.01 %/°F, at = 68 °F)		
Output			
Number of contacts 1:	1x changeover/SPDT (AgNi)		
Current rating:	16 A/AC1; 1 HP 240 Vac, 1/2 HP 120 Vac; PD. B300		
Breaking capacity:	4000 VA/AC1, 384 W/DC		
Electrical life (AC1):	100.000 ops.		
Number of contacts 2 (3):	x	1x chang./SPDT (AgNi)	2x chang./DPDT (AgNi)
Current rating:	x	16 A/AC1; 1 HP 240 Vac, 1/2 HP 120 Vac; PD. B300	8 A/AC1; 1/2 HP 240Vac; PD. B300
Breaking capacity:	x	4000 VA/AC1, 384 W/DC	2000 VA/AC1, 192 W/DC
Electrical life (AC1):	x	100.000 ops.	50.000 ops.
Switching voltage:	250 V AC/24 V DC		
Max. power dissipation:	1.2 W	2.4 W	2.4 W
Mechanical life:	10.000.000 ops.		
Control			
Control. terminals:	A1-S		
Load between S-A2:	Yes		
Impulse length:	min. 25 ms/max. unlimited		
Reset time:	max. 150 ms		
Other information			
Operating temperature:	-20 .. +55 °C (-4 .. 131 °F)		
Storage temperature:	-30 .. +70 °C (-22 .. 158 °F)		
Dielectric strength:			
supply - output 1	4kV AC		
supply - output 2 (3)	x	4kV AC	1kV AC
output 1 - output 2	x	4kV AC	1kV AC
output 2 - output 3	x	x	1kV AC
Operating position:	any		
Mounting:	DIN rail EN 60715		
Protection degree:	IP40 front panel/IP20 terminals		
Overvoltage category:	III.		
Pollution degree:	2		
Max. cable size (mm ²):	solid wire max. 1x 2.5 or 2x 1.5/ with sleeve max. 1x 2.5 (AWG 12)		
Dimensions:	90 x 17.6 x 64 mm (3.5" x 0.7" x 2.5")		
Weight:	UNI - 62 g (2.2 oz) 230 - 57 g (2 oz)	UNI - 85 g (3 oz) -	UNI - 85 g (3 oz) 230 - 80 g (2.8 oz)
Standards:	EN 61812-1		

Description

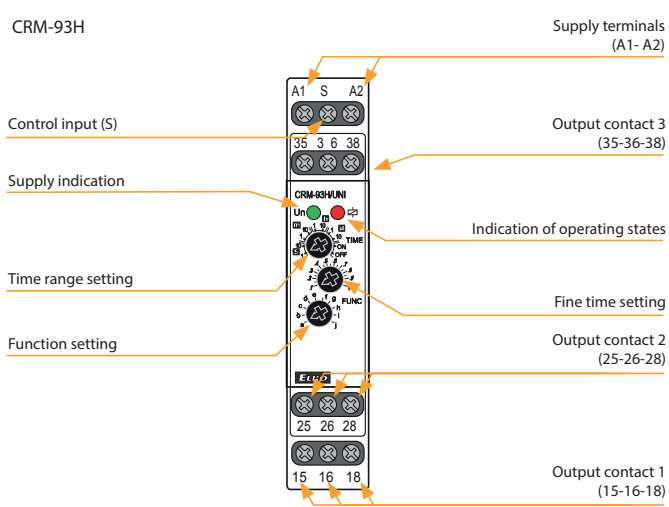

Connection

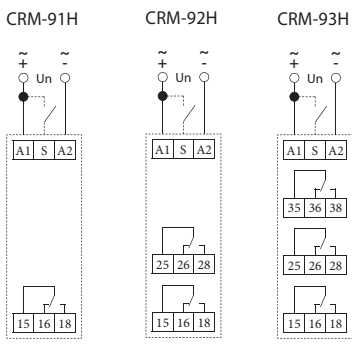

CRM-93H:
 The potential difference between the supply terminals (A1-A2), output contact 2 (25-26-28) and output contact 3 (35-36-38) must be a maximum of 250V AC rms/DC.

Possibility to connect load onto controlling input
 It is possible to connect the load (e.g.: contactor) between terminals S-A2, without any interruption of correct relay function.

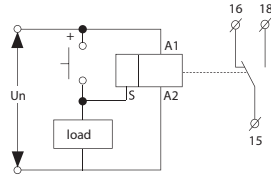

Indication of operating states

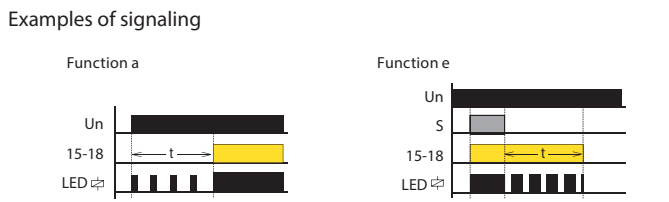

Function
 Function (page 17).

Function

**ON DELAY**

When the input voltage U is applied, timing delay t begins. Relay contacts R change state after time delay is complete. Contacts R return to their shelf state when input voltage U is removed. Trigger switch is not used in this function.

**INTERVAL ON**

When input voltage U is applied, relay contacts R change state immediately and timing cycle begins. When time delay is complete, contacts return to shelf state. When input voltage U is removed, contacts will also return to their shelfstate. Trigger switch is not used in this function.

**FLASHER - OFF first**

When input voltage U is applied, time delay t begins. When time delay t is complete, relay contacts R change state for time delay t. This cycle will repeat until input voltage U is removed. Trigger switch is not used in this function.

**FLASHER - ON first**

When input voltage U is applied, relay contacts R change state immediately and time delay t begins. When time delay t is complete, contacts return to their shelf state for time delay t. This cycle will repeat until input voltage U is removed. Trigger switch is not used in this function.

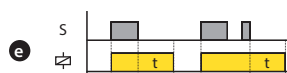
**OFF DELAY**

Input voltage U must be applied continuously. When trigger switch S is closed, relay contacts R change state. When trigger switch S is opened, delay t begins. When delay t is complete, contacts R return to their shelf state. If trigger switch S is closed before time delay t is complete, then time is reset. When trigger switch S is opened, the delay begins again, and relay contacts R remain in their energized state. If input voltage U is removed, relay contacts R return to their shelf state.

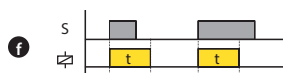
**SINGLE SHOT**

Upon application of input voltage U, the relay is ready to accept trigger signal S. Upon application of the trigger signal S, the relay contacts R transfer and the preset time t begins. During time-out, the trigger signal S is ignored. The relay resets by applying the trigger switch S when the relay is not energized.

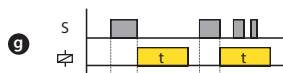
**SINGLE SHOT falling edge**

Upon application of input voltage U, the relay is ready to accept trigger signal S. Upon application of the trigger signal S, the relay contacts R transfer and the preset time t begins. At the end of the preset time t, the relay contacts R return to their normal condition unless the trigger switch S is opened and closed prior to time out t (before preset time elapses). Continuous cycling of the trigger switch S at a rate faster than the preset time will cause the relay contacts R to remain closed. If input voltage U is removed, relay contacts R return to their shelf state.

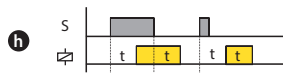
**ON/OFF DELAY**

Input voltage U must be applied continuously. When trigger switch S is closed, time delay t begins. When time delay t is complete, relay contacts R change state and remain transferred until trigger switch S is opened. If input voltage U is removed, relay contacts R return to their shelf state.

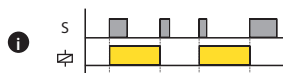
**MEMORY LATCH**

Input voltage U must be applied continuously. Output changes state with every trigger switch S closure. If input voltage U is removed, relay contacts R return to their shelf state.

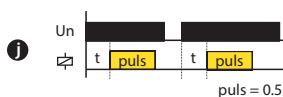
**PULSE GENERATOR**

Upon application of input voltage U, a single output pulse of 0.5 seconds is delivered to relay after time delay t. Power must be removed and reapplied to repeat pulse. Trigger switch is not used in this function.