



Product Overview & Application Examples





Time Relays

Monitoring / Protection Relays



Auxiliary Relays

Installation Contactors



Power Supplies

Digital Time Switches

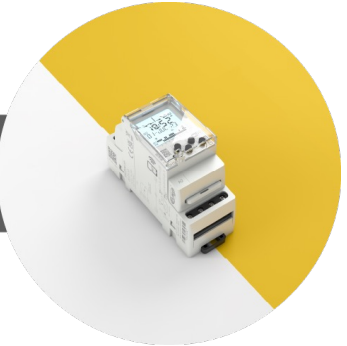



Time Relays



CRM-181J

Single-function time relay
1 function,
time range 0.1s - 100h,
1x16A changeover



CRM-91H

Multifunction time relay
10 functions,
time range 0.1s - 10days,
1x16A changeover



CRM-2T

Star / Delta time relay
1 function,
time range t1: 0.1s - 100days, t2: 0.1-1s,
2x16A changeover



PTRM-216KP

Multifunction time relay with
potential-free control input
11 pin octal socket,
10 functions,
time range 0.05s - 30days,
2x16A changeover



CRM-2H

Asymmetric flasher
2 functions,
time range 0.1s - 100days, 1x16A
changeover

Monitoring / Protection Relays



HRN3-80

Voltage monitoring relay in 3P
Selectable range 208-480V,
adjustable time delay 0.3-30s,
2 outputs



PRI-51

Current monitoring relay
1-phase, range 0.1-1/2/5/8/16A AC,
adjustable delay



HRN3-70

Voltage monitoring relay in 3P
Selectable range 190-500V,
adjustable time delay 0.3-30s,
2 outputs



PRI-32

Current monitoring relay
1-phase, range 1-20A AC



Auxiliary Relays



Installation Contactors



VS116U
Power relay
1x16A changeover,
1-module



VS120
Installation contactor
1x20A NO/NC



VS308U
Power relay
3x8A changeover
1-module



VS363
Installation contactor
3x63A NO



Power Supplies



PS3M
Power supply
DC 12V/54W
DC 24V/60W



PS1M
Power supply
DC 12V/15W
DC 24V/15W

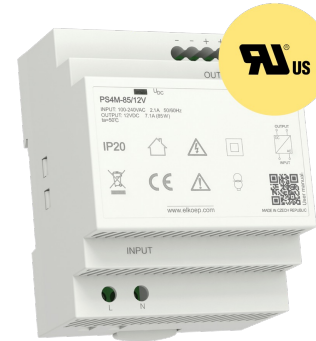

PS4M
Power supply
DC 12V/85W
DC 24V/92W



PS2M
Power supply
DC 12V/24W
DC 24V/30W



PS6M
Power supply
DC 12V/135W
DC 24V/150W



SHT-13

Multifunction digital time switch

SHT-13/1

SHT-13/2

- All programs in one device (daily, weekly, yearly and astronomical)
- UNiversal supply voltage in the range of AC/DC 24 - 240 V (AC 50-60 Hz)
- Simple setting after the first start-up
- User-replaceable battery to back up the set time during power outages
- Built-in web server for setup and control via Wi-Fi connection
- Time synchronization through NTP server (require internet connection)
- Possibility of permanent connection to the local network
- New well-arranged display with white backlight

Digital Time Switches

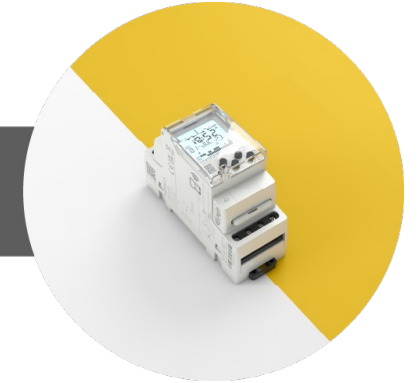

- ASTROnomic program: manual entry of coordinates or selecting from one of more than 500 preset cities
 - selection of days of the week
 - astro interrupt function (night break): controls the sunrise/sunset times and compares them with the set OFF/ON times
 - high position accuracy thanks to two decimal places in latitude/longitude
- One/two channel design (each with an operating hours counter)
- Pulse/cycle output mode
- Transition of summer/winter time - AUTO or OFF
- Sealable transparent front panel cover
- PIN code protection against unauthorized changes
- Wireless firmware update - current version 1.46



CRM-91H

Multifunction time relay
10 functions,
time range 0.1s - 10days,
1x16A changeover

Multifunction time relay for universal use in automation, control and regulation or in house installations.

Comfortable and well-arranged function and time-range setting by rotary switches.

Multifunction red LED flashes or shines depending on the operating status.

AC/DC 24-240V CONTROL VOLTAGE



Connection

CRM-91H

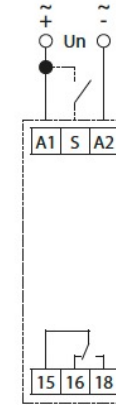

CRM-93H

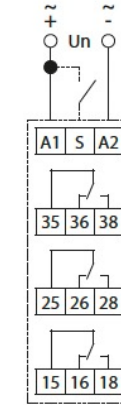

CRM-93H:

The potential difference between the supply terminals (A1-A2), output contact 2 (25-26-28) and output contact 3 (35-36-38) must be a maximum of 250V AC rms/DC.

Possibility to connect load onto controlling input

It is possible to connect the load (e.g.: contactor) between terminals S-A2, without any interruption of correct relay function.

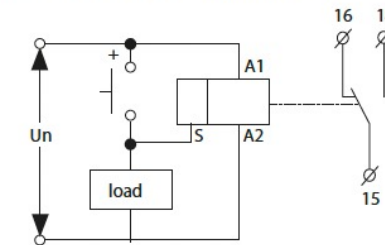

Indication of operating states

Examples of signaling

Function a

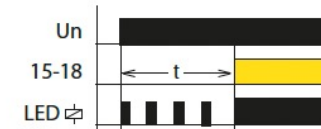

Function e





CRM-91H
 Multifunction time relay
 10 functions,
 time range 0.1s - 10days,
 1x16A changeover



ON DELAY
 When the input voltage U is applied, timing delay t begins. Relay contacts R change state after time delay is complete. Contacts R return to their shelf state when input voltage U is removed. Trigger switch is not used in this function.

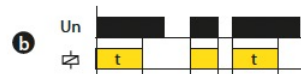

INTERVAL ON
 When input voltage U is applied, relay contacts R change state immediately and timing cycle begins. When time delay is complete, contacts return to shelf state. When input voltage U is removed, contacts will also return to their shelfstate. Trigger switch is not used in this function.

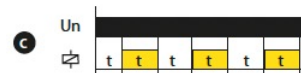

FLASHER - OFF first
 When input voltage U is applied, time delay t begins. When time delay t is complete, relay contacts R change state for time delay t. This cycle will repeat until input voltage U is removed. Trigger switch is not used in this function.



FLASHER - ON first
 When input voltage U is applied, relay contacts R change state immediately and time delay t begins. When time delay t is complete, contacts return to their shelf state for time delay t. This cycle will repeat until input voltage U is removed. Trigger switch is not used in this function.

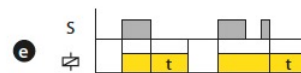

OFF DELAY
 Input voltage U must be applied continuously. When trigger switch S is closed, relay contacts R change state. When trigger switch S is opened, delay t begins. When time delay t is complete, contacts R return to their shelf state. If trigger switch S is closed before time delay t is complete, then time is reset. When trigger switch S is opened, the delay begins again, and relay contacts R remain in their energized state. If input voltage U is removed, relay contacts R return to their shelf state.

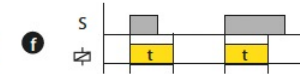

SINGLE SHOT
 Upon application of input voltage U, the relay is ready to accept trigger signal S. Upon application of the trigger signal S, the relay contacts R transfer and the preset time t begins. During time-out, the trigger signal S is ignored. The relay resets by applying the trigger switch S when the relay is not energized.

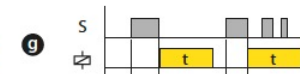

SINGLE SHOT falling edge
 Upon application of input voltage U, the relay is ready to accept trigger signal S. Upon application of the trigger signal S, the relay contacts R transfer and the preset time t begins. At the end of the preset time t, the relay contacts R return to their normal condition unless the trigger switch S is opened and closed prior to time out t (before preset time elapses). Continuous cycling of the trigger switch S at a rate faster than the preset time will cause the relay contacts R to remain closed. If input voltage U is removed, relay contacts R return to their shelf state.

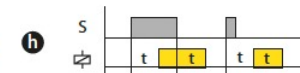

ON/OFF DELAY
 Input voltage U must be applied continuously. When trigger signal S is closed, time delay t begins. When time delay t is complete, relay contacts R change state and remain transferred until trigger switch S is opened. If input voltage U is removed, relay contacts R return to their shelf state.



MEMORY LATCH
 Input voltage U must be applied continuously. Output changes state with every trigger switch S closure. If input voltage U is removed, relay contacts R return to their shelf state.

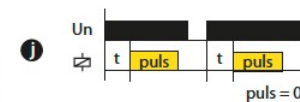

PULSE GENERATOR
 Upon application of input voltage U, a single output pulse of 0.5 seconds is delivered to relay after time delay t. Power must be removed and reapplied to repeat pulse. Trigger switch is not used in this function.



Time Relays

DIN mounted / 8 pin / 11. pin

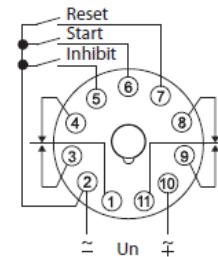
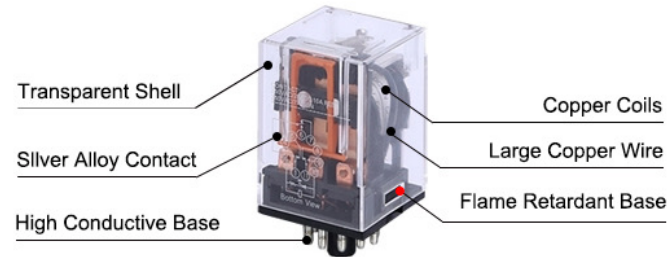
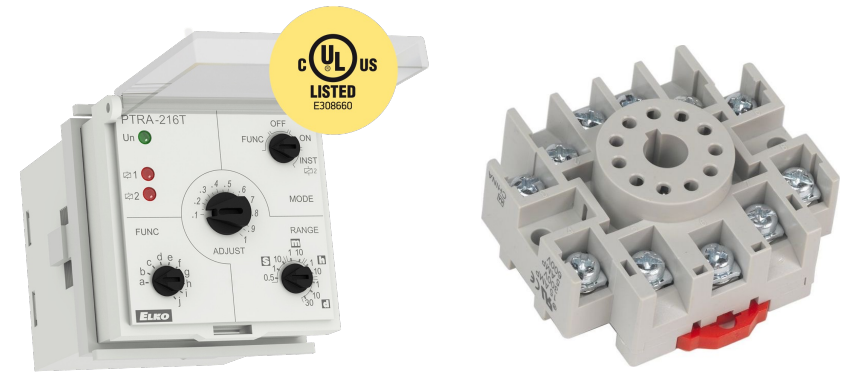
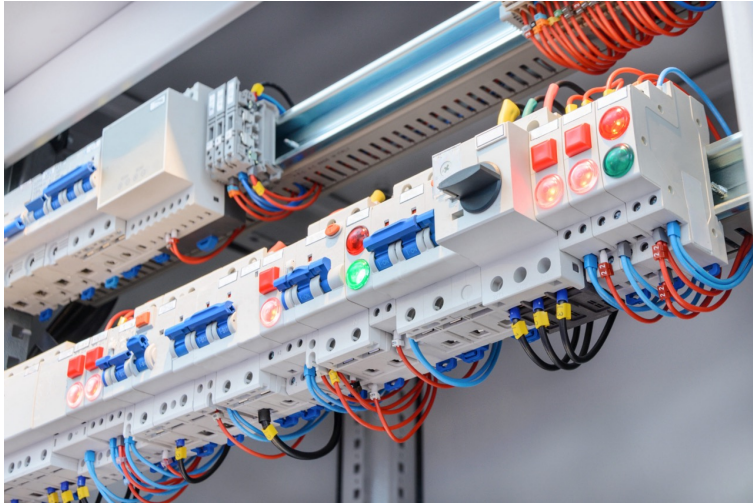

Auxiliary Relays

AC/DC 24-240V CONTROL VOLTAGE

VS116U

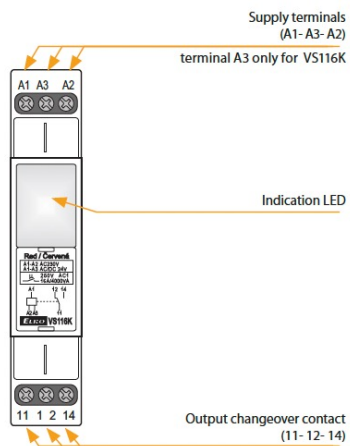

VS116U

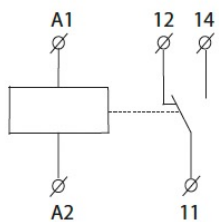

VS308U

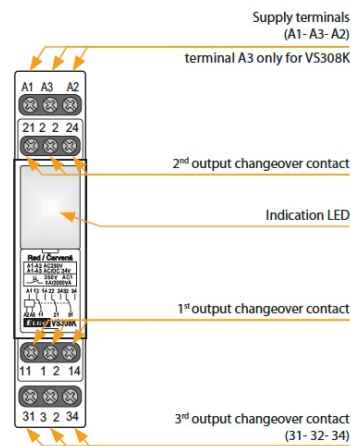

VS308U

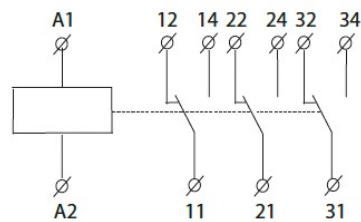

VS116U

Power relay
1x16A changeover,
1-module



VS308U

Power relay
3x8A changeover
1-module

Application examples

Monitoring / Protection Relays



HRN3-80

Voltage monitoring relay in 3P
Selectable range 208-480V,
adjustable time delay 0.3-30s,
2 outputs

Detects overvoltage, undervoltage, window, phase sequence

- Detects Voltage in UPS cabinet to switch from utility power to batteries
- Detects overvoltage in a control panel circuits to disconnect and protects other components
- Detects undervoltage to stop a process a prevent unexpected stop and failure
- Detects correct phase order to prevent motor running wrong direction
- Detects balanced 3 phases to prevent motor from overheating



HRN3-70

Voltage monitoring relay in 3P
Selectable range 190-500V,
adjustable time delay 0.3-30s,
2 outputs

Application examples

Monitoring / Protection Relays



PRI-51

Current monitoring relay
1-phase, range 0.1-1/2/5/8/16A AC,
adjustable delay
Monitoring of current by built-in
transformer, 7 ranges
Supply and output as PRI-32,
difference from PRI-32: direct
monitoring and finer ranges
higher sensitivity = better accuracy



PRI-32

Current monitoring relay
1-phase, range 1-20A AC
Monitoring by current transformer (wire
through an opening, galv. separated, no
heat loss), adjust. current 1-20 A
Multivoltage AC 24-240 and DC 24 V,
Output 8 A changeover
Current transformer is a part of the
product

Heating bars in sliding rails, heating cables, indication of
current flow controlling of 1-phase motor consumption

- Detects current flow - indicates operation of a heating
cable
- Detect no current flow - indicates a failure of a heating
cable
- Indicates operation of a single-phase motor in an
automated process - logistic center, airport conveyor
belt
- Monitors function of a light bulb (sport field, street
lighting, mall, office building, elevators, public garage...



Time Relays



CRM-91H

Multifunction time relay
10 functions,
time range 0.1s - 10days,
1x16A changeover

Application examples

- Flashing light control (time on, time off)
- Engine auto start control
- Furnace safety purge control
- Motor soft-start delay control
- Conveyor belt sequence delay



Application examples

- **Electrical Panel production**
- Lighting
- Industrial Heating and Cooling Systems
- Wind and solar power generation
- Telecommunications Infrastructure
- Mining
- Heavy industry

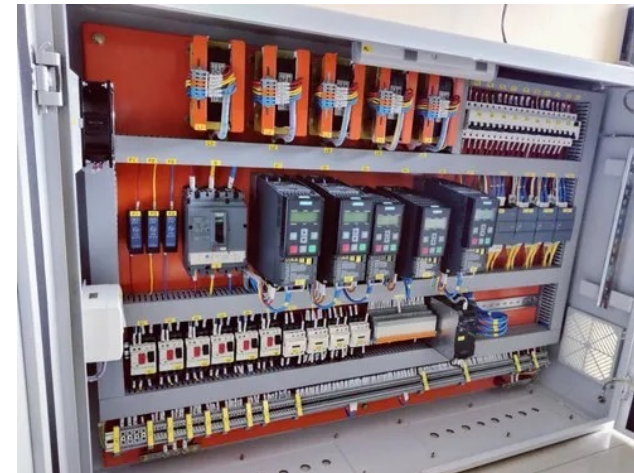

Application examples

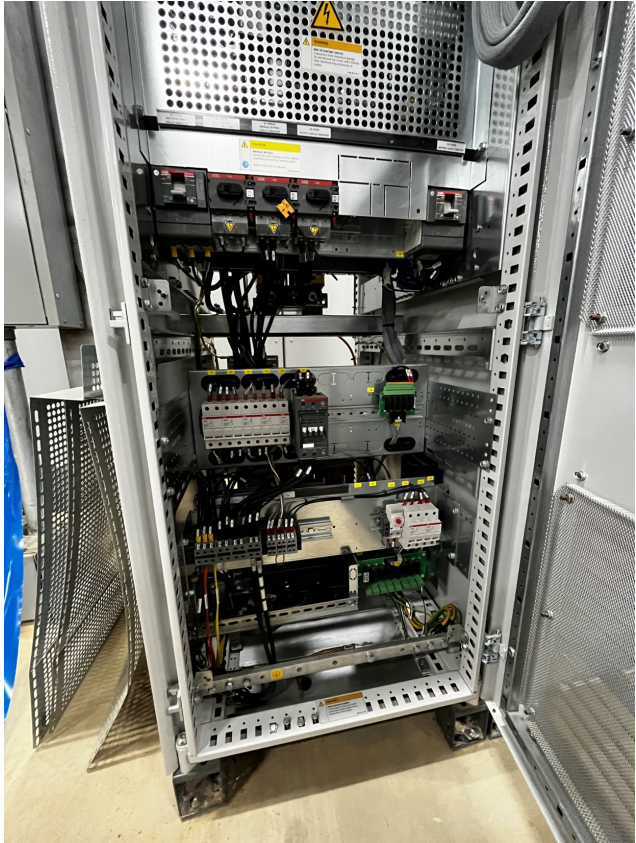
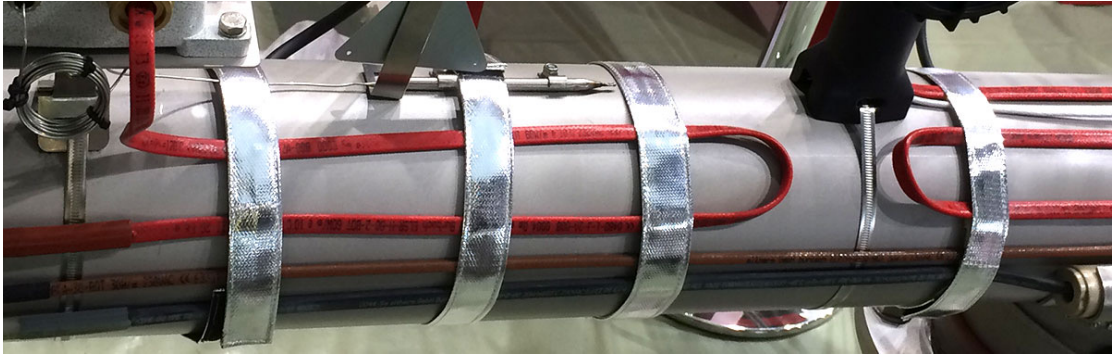

Application examples



Application examples

- **Electrical Panel production**
- Water Treatment and Management Systems
- EV charging systems
- Manufacturing plants
- Logistic centers, warehouses
- Telecommunications Infrastructure



Application examples

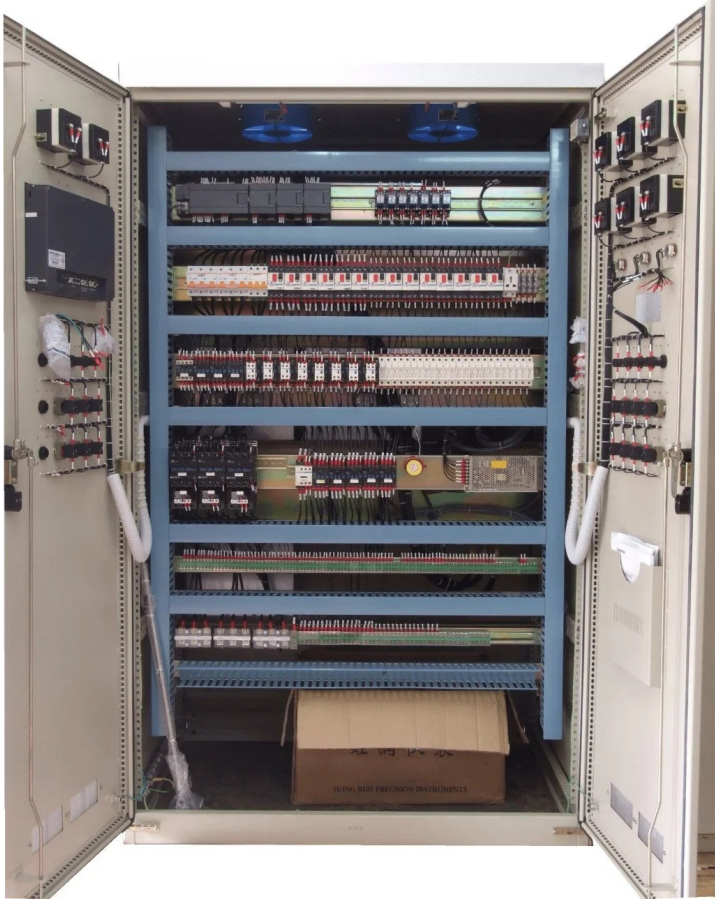

Application examples

- **Electrical Panel production**
- Pulp and paper
- Metal mills
- Marine and offshore applications

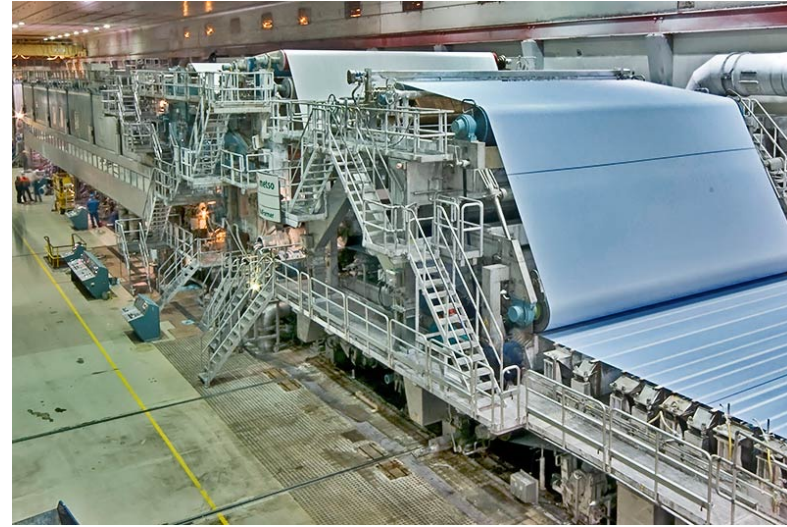

Application examples

- E-HOUSE production shops
- Mining sites
- Oil and gas plants and stations, refineries
- LNG terminals, compressor stations

Oil field pump station



Refinery



Mine site E-house





Jan Pacovsky
Managing Member, CEO

pacovsky@elkoepna.com

+1 (608) 746-1332



Mike Zadravec
Director of Sales

zadravec@elkoepna.com

+1 (602) 315-5048



Milana Pabon
Logistics & Support
Director

elkosupport@elkoepna.com

+1 (602) 315-5048



Jan Hladik
Technical & Product
Director

hladik@elkoepna.com

+1 (312) 439-2098

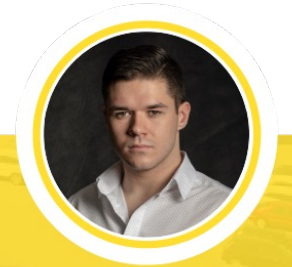

Vaclav Rychtarik
Director of Marketing

rychtarik@elkoepna.com